

GNS-3912Ax-Bx-Cx-Dx (SINGLE DIGIT LED DISPLAY)

GNS-3912 Series

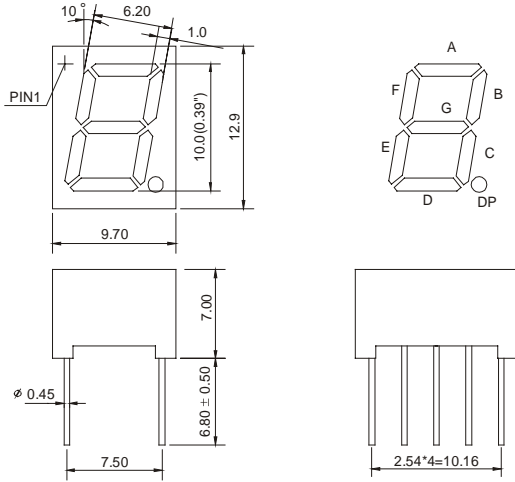

GNS-3912Ax

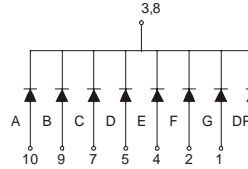

GNS-3912Bx

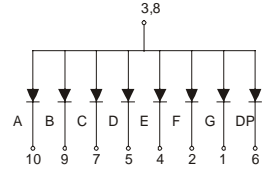

GNS-3912Cx

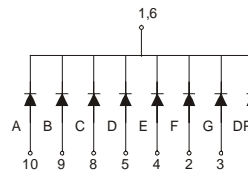

GNS-3912Dx

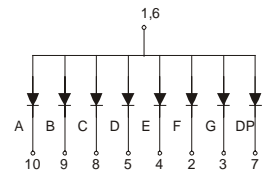

Features:

*0.39 INCH HIGH CHARACTER.

*EXCELLENT CHARACTER APPEARANCE.

*COMMON CATHODE OR COMMON ANODE.

*I.C. COMPATIBLE.

*LOW POWER CONSUMPTION.

Part Number	EMITTED COLOR		Common Cathode or Common Anode	Peak Wavelength (nm)	Vf (v) Typ	If (mA)	Intensity Per Segment (mcd)	
							Min.	Typ.
GNS-3912AE	GaAsP/GaP	Hi.effi Red	Common Cathode	635	2.0	20	9	12
GNS-3912AG	GaP	Green		565	2.1	20	8	11
GNS-3912AY	GaAsP/GaP	Yellow		585	2.0	20	9	12
GNS-3912AS	GaAlAs	Super Red		660	1.8	20	10	13
GNS-3912AD	GaAlAs	Ultra Red		660	1.8	20	25	30
GNS-3912AUE	AlGaInP	Ultra Red		625	2.0	20	30	35
GNS-3912AU Y	AlGaInP	Ultra Yellow		590	2.0	20	30	35
GNS-3912BE	GaAsP/GaP	Hi.effi Red	Common Anode	635	2.0	20	9	12
GNS-3912BG	Gap	Green		565	2.1	20	8	11
GNS-3912BY	GaAsP/GaP	Yellow		585	2.0	20	9	12
GNS-3912BS	GaAlAs	Super Red		660	1.8	20	10	13
GNS-3912BD	GaAlAs	Super Red		660	1.8	20	25	30
GNS-3912BUE	AlGaInP	Ultra Red		625	2.0	20	30	35
GNS-3912BUY	AlGaInP	Ultra Yellow		590	2.0	20	30	35

GNS-3912CE	GaAsP/GaP	Hi.effi Red	Common Cathode	635	2.0	20	9	12
GNS-3912CG	GaP	Green		565	2.1	20	8	11
GNS-3912CY	GaAsP/GaP	Yellow		585	2.0	20	9	12
GNS-3912CS	GaAlAs	Super Red		660	1.8	20	10	13
GNS-3912CD	GaAlAs	Ultra Red		660	1.8	20	25	30
GNS-3912CUE	AlGaInP	Ultra Red		625	2.0	20	30	35
GNS-3912CUY	AlGaInP	Ultra Yellow		590	2.0	20	30	35
GNS-3912DE	GaAsP/GaP	Hi.effi Red	Common Anode	635	2.0	20	9	12
GNS-3912DG	Gap	Green		565	2.1	20	8	11
GNS-3912DY	GaAsP/GaP	Yellow		585	2.0	20	9	12
GNS-3912DS	GaAlAs	Super Red		660	1.8	20	10	13
GNS-3912DD	GaAlAs	Super Red		660	1.8	20	25	30
GNS-3912DUE	AlGaInP	Ultra Red		625	2.0	20	30	35
GNS-3912DUY	AlGaInP	Ultra Yellow		590	2.0	20	30	35