



信亿电子科技有限公司

Sineyi Electronic Technology Co., Ltd



# QUICK CONNECTOR





# 信亿电子科技有限公司

Sineyi Electronic Technology Co., Ltd.

## 公司简介 Brief Introduction

信亿电子科技有限公司是一家合资高新技术企业。在大陆分别设有接线端子配件厂、结束套管制品厂。公司位于具有中国塑料城和中国模具城优势的余姚。北由杭州湾跨海大桥直连上海，东连中国第一大港北仑港，交通极为方便。

多年来，我们不断致力于产品的研发，使企业得到了快速的发展。公司拥有先进、完善的全套生产设备 & 测试仪器；具有雄厚的技术保障能力；拥有完善的质量保证体系。公司通过了 ISO9001:2000 管理体系认证，产品通过了 UL CQC CCC TUV CE... 并取得了专利号为：ZL200720305090.0 / ZL200730281340.7 的国家专利。产品销售网络已遍及国内主要城市，并远销东南亚、欧美、非洲等一些国家。

为了能把“SINEYI”品牌扬名世界，我们将继续秉承一贯的专业精神，为您提供更优良的品质、更合理的价格、更贴心的服务。

Sineyi Electronic Technology Co., Ltd. is a Sino-foreign joint ventures, in connection with the mainland, respectively accessories factory, Harness casing Products Factory. We are located in Yuyao city, which is known as the Molding Kingdom and the Plastic Kingdom of China. It's near Hangzhou Bay Bridge straight of Shanghai northward and China's port called Beilun port eastward, the traffic is very convenient. Over the years, we have been committed to products' research and development, so we has been developed rapidly. The company has a full set of advanced and complete production equipment and testing equipment; have strong technical support capabilities; have perfect quality assurance system. The company has past ISO9001: 2000 management system certification, product certification adopted . UL CQC CCC TUV CE... And obtained a patent for: ZL200720305090.0 / ZL200730281340.7 of the national patent. Product sales network across major cities in China and exported to Southeast Asia, Europe and the United States, Africa and other regions.

In order to make "SINEYI" become a world famous brand, we will continue to uphold the usual professionalism, to provide you with better quality, more reasonable prices, more intimate services. We sincerely look forward to cooperate with you .



# 导线连接器 Connector XY221



2P



3P



4P



5P

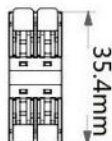

14.2mm

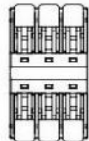

20.7mm

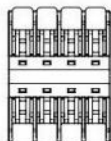

27.2mm



33.7mm



2J



3J



4J



5J

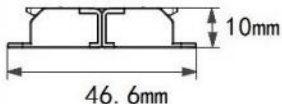

46.6mm

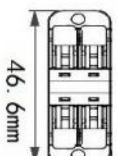

14.3mm

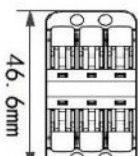

20.9mm

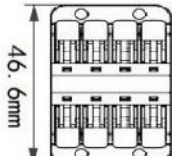

27.2mm

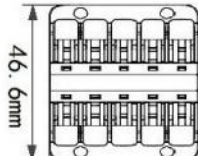

33.7mm

Connection mode (2 seconds quick-connection)



胶壳材质Housing: pc

夹紧件材质Metal Part: 铜Brass

锁线弹片材质Metal: 不锈钢Steel

环境温度Temperature: -40° C to +85° C

欧洲标准Eropre Stander:

250V 16A 0.5~2.5mm<sup>2</sup> (f) 0.5~4.0mm<sup>2</sup> (r)

美国标准USA Stander:

600V 20A 24-12AWG str/sol

中国标准China Stander:

450V 32A 0.5~2.5mm<sup>2</sup> (f) 0.5~4.0mm<sup>2</sup> (r)

# 导线连接器 Connector XY221 (6mm<sup>2</sup>)



位数N:2JJ/3JJ/4JJ/5JJ/6JJ/7JJ/  
8JJ/9JJ/10JJ/11JJ/12JJ



手柄颜色: 橘色 (另有蓝/黄/棕)  
HANDLE COLOR: Regular Orange,  
other blue/yellow/brown

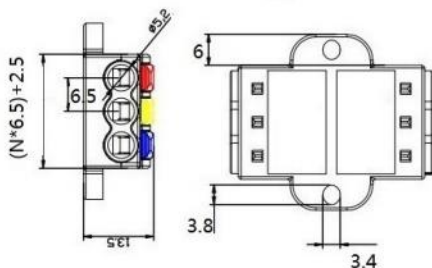
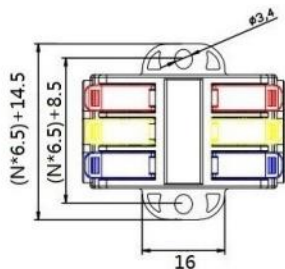
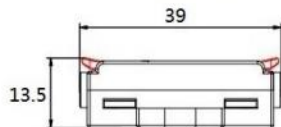

位数N:2P/3P/4P/5P/6P/7P/8P/  
9P/10P/11P/12P

手柄颜色: 橘色 (另有蓝/黄/棕)  
HANDLE COLOR: Regular Orange,  
other blue/yellow/brown

胶壳材质Housing: PA

夹紧件材质Metal Part: 铜Brass

锁线弹片材质Metal: 不锈钢Steel

环境温度Temperature: -40° C to +85° C

欧洲标准Erope Stander:

450V 41A 0.5~6.0mm<sup>2</sup> (f) 0.5~6.0mm<sup>2</sup> (r)

美国标准USA Stander:

600V 30A 20-10AWG str/sol

中国标准China Stander:

450V 41A 0.5~6.0mm<sup>2</sup> (f) 0.5~6.0mm<sup>2</sup> (r)

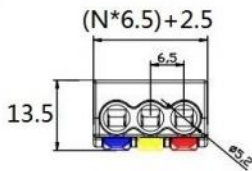
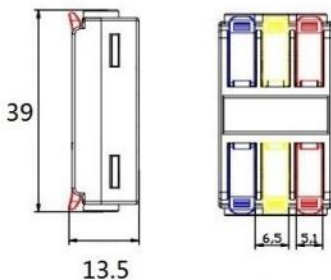

# 导线连接器 Connector XY221

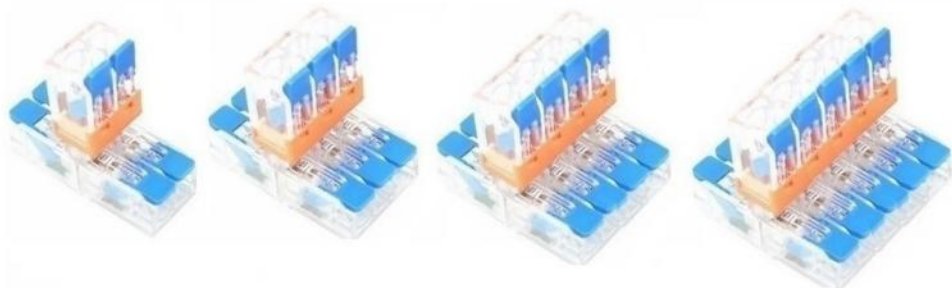

2T

3T

4T

5T

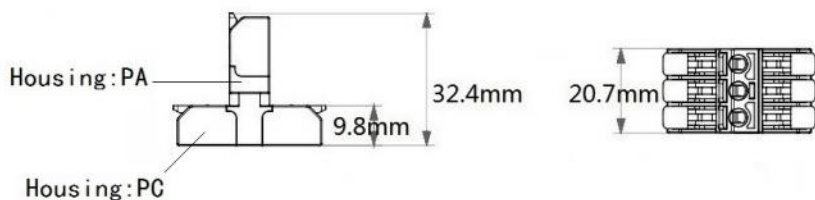

Connection mode (2 seconds quick-connection)



胶壳材质Housing: PA, PC

夹紧件材质Metal Part: 铜Brass

锁线弹片材质Metal: 不锈钢Steel

环境温度Temperature:  $-40^{\circ}\text{C}$  to  $+85^{\circ}\text{C}$

欧洲标准Europe Standers:

450V 16A 0.5~2.5mm<sup>2</sup> (f) 0.5~4.0mm<sup>2</sup> (r)

美国标准USA Standers:

600V 20A 24~12AWG str/sol

中国标准China Standers:

450V 32A 0.5~2.5mm<sup>2</sup> (f) 0.5~4.0mm<sup>2</sup> (r)

# 导线连接器 Connector XY221M XY221F



2P



3P



4P



5P

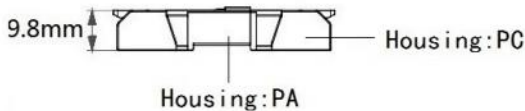
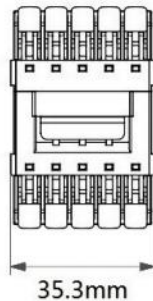
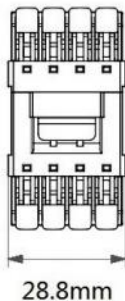
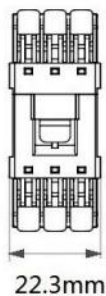
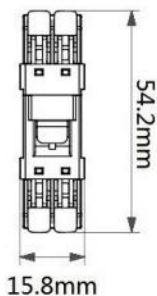

Connection mode (2 seconds quick-connection)

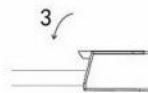
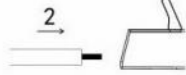

胶壳材质Housing: PC, PA

夹紧件材质Metal Part: 铜Brass

锁线弹片材质Metal: 不锈钢Steel

环境温度Temperature: -40° C to +85° C

欧洲标准Eropre Stander:

450V 16A 0.5~2.5mm<sup>2</sup> (f) 0.5~4.0mm<sup>2</sup> (r)

美国标准USA Stander:

600V 20A 24~12AWG str/sol

中国标准China Stander:

450V 32A 0.5~2.5mm<sup>2</sup> (f) 0.5~4.0mm<sup>2</sup> (r)

# 导线连接器 Connector XY221M XY221F



182-2P

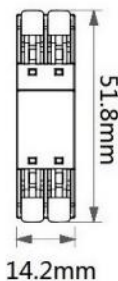

182-2-4

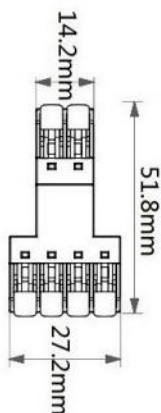

182-4P

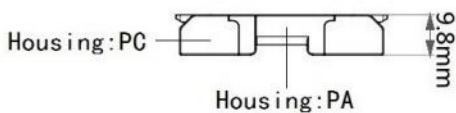
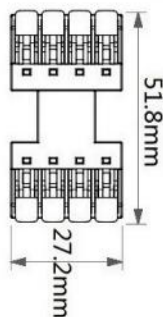

Connection mode (2 seconds quick-connection)



胶壳材质Housing: PC, PA

夹紧件材质Metal Part: 铜Brass

锁线弹片材质Metal: 不锈钢Steel

环境温度Temperature:  $-40^{\circ}\text{C}$  to  $+85^{\circ}\text{C}$

欧洲标准Europe Stander:

250V 10A 0.5~2.5mm<sup>2</sup>

美国标准USA Stander:

600V 6A 24-12AWG str/sol

中国标准China Stander:

250V 10A 0.5~2.5mm<sup>2</sup>

# 导线连接器 Connector XY221M XY221F



P02-2-4

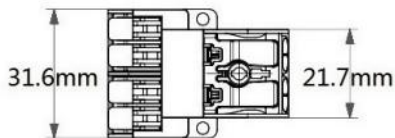

P02-2-6

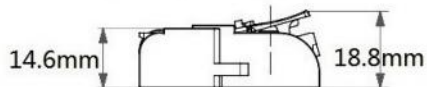
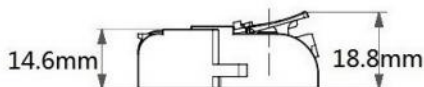
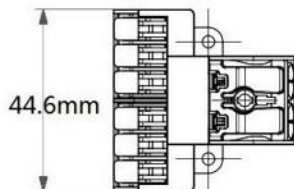

P02-2-8

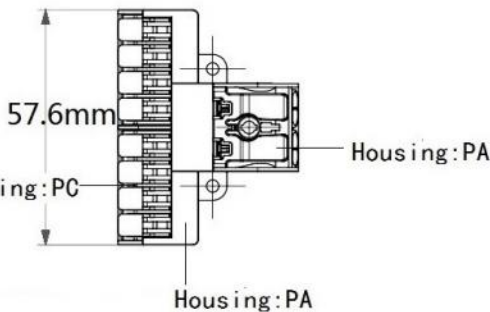

P02-2-10

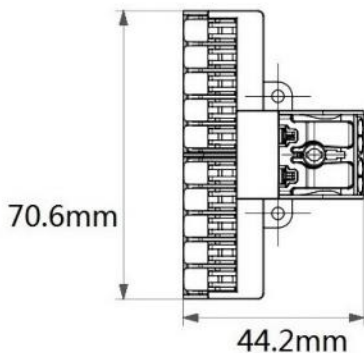

胶壳材质Housing : PC,PA

夹件材质Metal Part : 铜Brass

锁线弹片材质Metal : 不锈钢Steel

环境温度Temperature : -40°C to +85°C

欧洲标准Europe Stander : 250V 10A 0.5~2.5mm<sup>2</sup>

美国标准USA Stander : 600V 6A 24-12AWG str/sol

中国标准China Stander : 250V 10A 0.5~2.5mm<sup>2</sup>

# 导线连接器 Connector XY222



1P

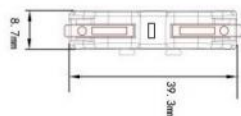
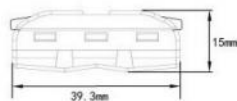

2P

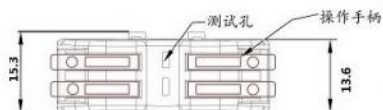
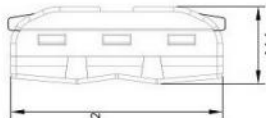

3P

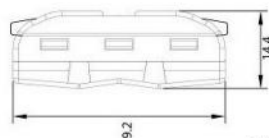

手柄颜色: 橘色 (另有蓝/黄/棕)

HANDLE COLOR: Regular Orange, other blue/yellow/brown

## DIY拼接:



1P+1P+...

1P+2P...

1P+3P...

2P+2P...

2P+3P...

胶壳材质Housing: PA

夹紧件材质Metal Part: 铜Brass

锁线弹片材质Metal: 不锈钢Steel

环境温度Temperature: -40° C to +85° C

欧洲标准Erope Stander:

250V 32A 0.5~2.5mm<sup>2</sup> (f) 0.5~4.0mm<sup>2</sup> (r)

美国标准USA Stander:

600V 20A 24-12AWG str/sol

中国标准China Stander:

450V 32A 0.5~2.5mm<sup>2</sup> (f) 0.5~4.0mm<sup>2</sup> (r)

# 导线连接器 Connector XY222

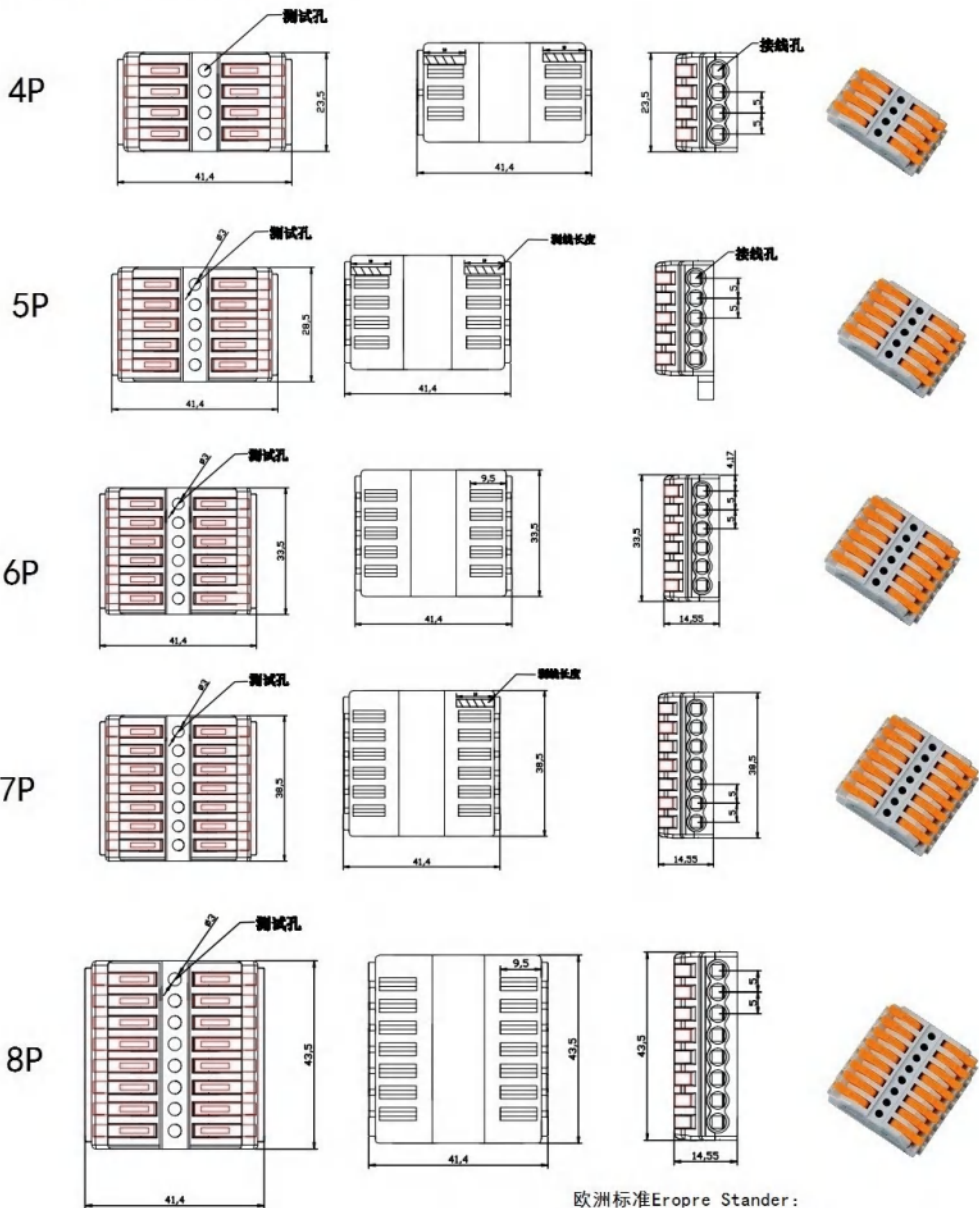

胶壳材质Housing: PA  
 夹件材质Metal Part: 铜Brass  
 锁线弹片材质Metal: 不锈钢Steel  
 环境温度Temperature: -40°C to +85°C

欧洲标准Euprope Stander:  
 250V 32A 0.5~2.5mm<sup>2</sup> (f) 0.5~4.0mm<sup>2</sup> (r)  
 美国标准USA Stander:  
 600V 20A 24-12AWG str/sol  
 中国标准China Stander:  
 450V 32A 0.5~2.5mm<sup>2</sup> (f) 0.5~4.0mm<sup>2</sup> (r)

# 导线连接器 Connector XY222



2J

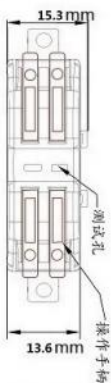

手柄颜色：橘色（另有蓝/黄/棕）  
HANDLE COLOR: Regular Orange,  
other blue/yellow/brown



3J

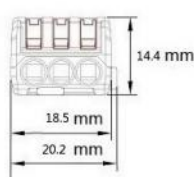
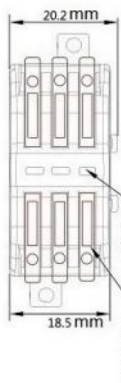
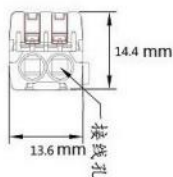

DIY拼接：2J+2J, 2J+3J...



胶壳材质Housing: PA  
夹紧件材质Metal Part: 铜Brass  
锁线弹片材质Metal: 不锈钢Steel  
环境温度Temperature: -40° C to +85° C  
欧洲标准Erope Stander:  
250V 32A 0.5~2.5mm<sup>2</sup> (f) 0.5~4.0mm<sup>2</sup> (r)  
美国标准USA Stander:  
600V 20A 24-12AWG str/sol  
中国标准China Stander:  
450V 32A 0.5~2.5mm<sup>2</sup> (f) 0.5~4.0mm<sup>2</sup> (r)

Connection mode (2 seconds quick-connection)

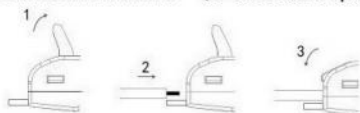

# 导线连接器 Connector XY222

手柄颜色: 橘色 (另有蓝/黄/棕)

HANDLE COLOR: Regular Orange, other blue/yellow/brown



1-2R

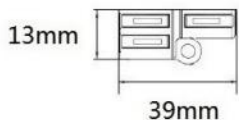

1-2M

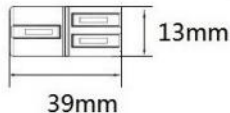

1-2L

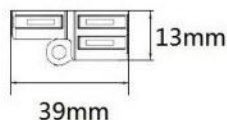

1-3R

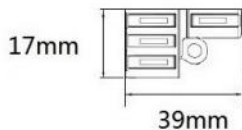

1-3M

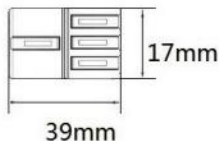

1-3L

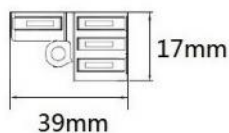

## DIY拼接



2-4



2-6



3-6



3-9



4-8



4-12

胶壳材质Housing: PA

夹零件材质Metal Part: 铜Brass

锁线弹片材质Metal: 不锈钢Steel

环境温度Temperature: -40° C to +85° C

欧洲标准Europe Stander:

250V 32A 0.5~2.5mm<sup>2</sup> (f) 0.5~4.0mm<sup>2</sup> (r)

美国标准USA Stander:

600V 20A 24-12AWG str/sol

中国标准China Stander:

450V 32A 0.5~2.5mm<sup>2</sup> (f) 0.5~4.0mm<sup>2</sup> (r)

# 导线连接器 Connector XY222



2-4

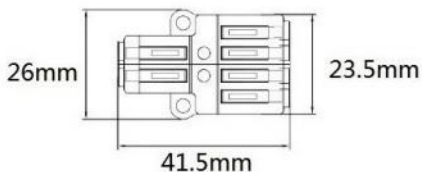

2-6

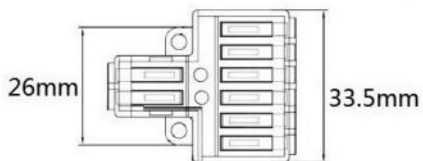

3-6

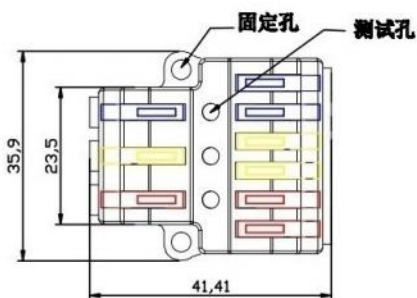

3-9

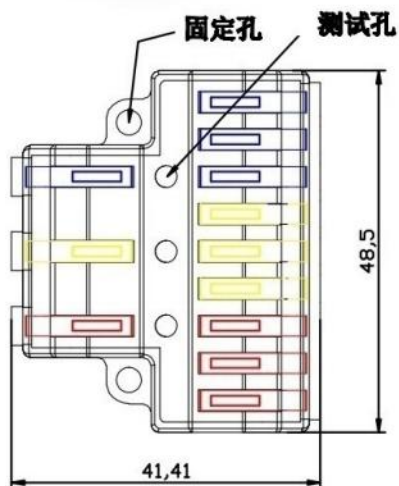

胶壳材质Housing: PA  
 夹紧件材质Metal Part: 铜Brass  
 锁线弹片材质Metal: 不锈钢Steel  
 环境温度Temperature:  $-40^{\circ}\text{C}$  to  $+85^{\circ}\text{C}$   
 欧洲标准Eropre Stander:  
 250V 32A 0.5~2.5mm<sup>2</sup> (f) 0.5~4.0mm<sup>2</sup> (r)  
 美国标准USA Stander:  
 600V 20A 24-12AWG str/sol  
 中国标准China Stander:  
 450V 32A 0.5~2.5mm<sup>2</sup> (f) 0.5~4.0mm<sup>2</sup> (r)

# 导线连接器 Connector XY222

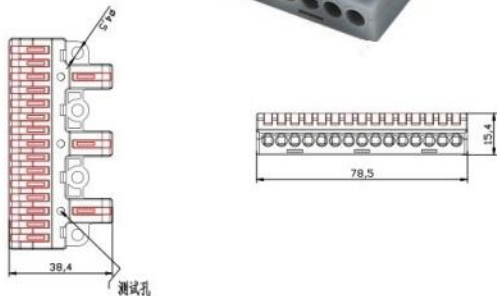
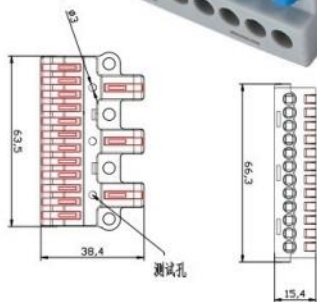
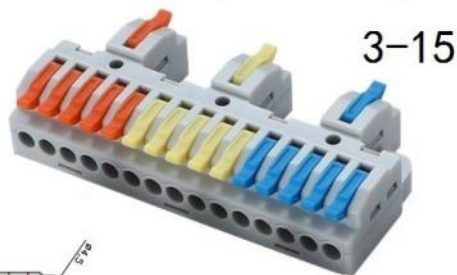
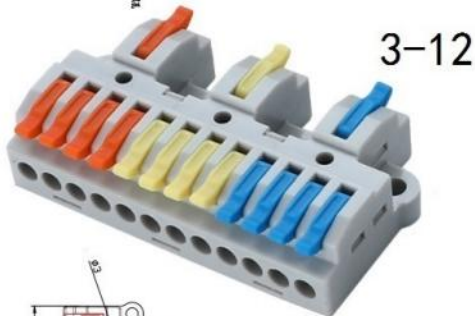
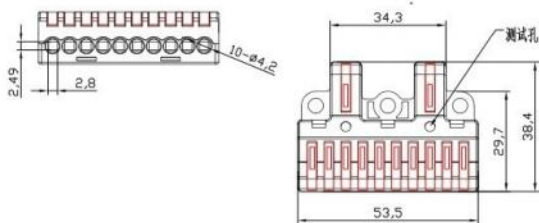
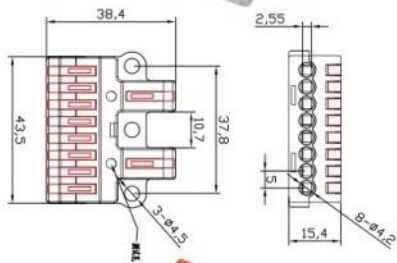

胶壳材质Housing: PA  
 夹零件材质Metal Part: 铜Brass  
 锁线弹片材质Metal: 不锈钢Steel  
 环境温度Temperature: -40° C to +85° C  
 欧洲标准Erope Stander:  
 250V 32A 0.5~2.5mm<sup>2</sup> (f) 0.5~4.0mm<sup>2</sup> (r)  
 美国标准USA Stander:  
 600V 20A 24-12AWG str/sol  
 中国标准China Stander:

# 导线连接器 Connector XY222-J



2-8

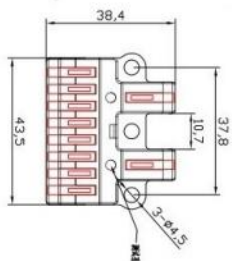

2-10

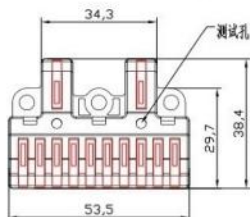

3-12

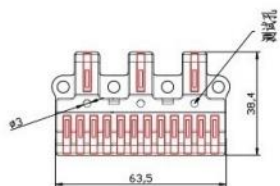

3-15

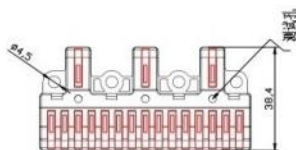

胶壳材质Housing: PA  
 夹紧件材质Metal Part: 铜Brass  
 锁线弹片材质Metal: 不锈钢Steel  
 环境温度Temperature: -40° C to +85° C

欧洲标准Erope Stander:  
 250V 32A 0.5~2.5mm<sup>2</sup> (f) 0.5~4.0mm<sup>2</sup> (r)  
 美国标准USA Stander:  
 600V 20A 24-12AWG str/sol  
 中国标准China Stander:  
 450V 32A 0.5~2.5mm<sup>2</sup> (f) 0.5~4.0mm<sup>2</sup> (r)

# 导线连接器 Connector XY222

手柄颜色: 橘色 (另有蓝/黄/棕)

HANDLE COLOR: Regular Orange, other blue/yellow/brown

## 1P(T)

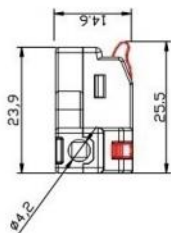
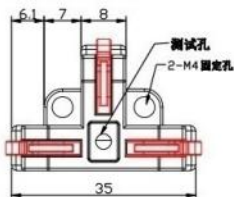

## 2P(T)

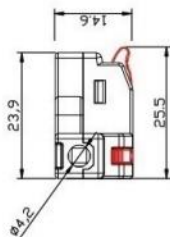
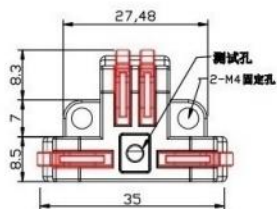

胶壳材质Housing: PA

夹紧件材质Metal Part: 铜Brass

锁线弹片材质Metal: 不锈钢Steel

环境温度Temperature:  $-40^{\circ}\text{C}$  to  $+85^{\circ}\text{C}$

欧洲标准Europe Stander:

250V 32A 0.5~2.5mm<sup>2</sup> (f) 0.5~4.0mm<sup>2</sup> (r)

美国标准USA Stander:

600V 20A 24-12AWG str/sol

中国标准China Stander:

450V 32A 0.5~2.5mm<sup>2</sup> (f) 0.5~4.0mm<sup>2</sup> (r)

# 导线连接器 Connector XY222

2JJ

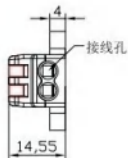
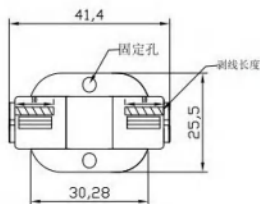
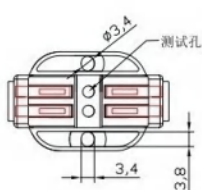

3JJ

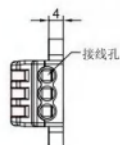
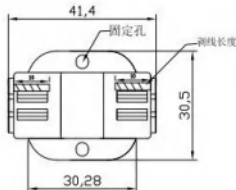
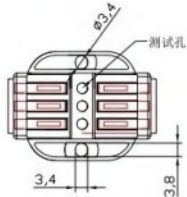

4JJ

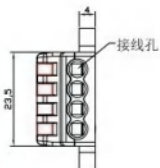
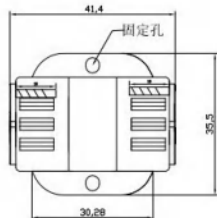
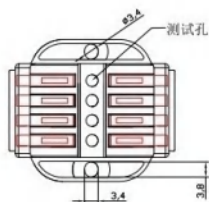

5JJ

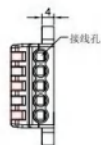
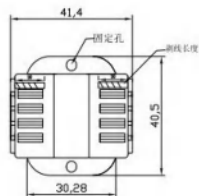
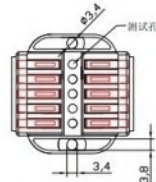

6JJ

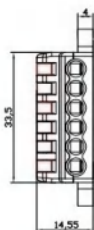
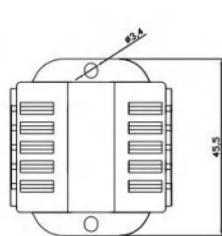
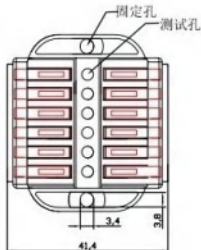

胶壳材质Housing: PA  
 夹紧件材质Metal Part: 铜Brass  
 锁线弹片材质Metal: 不锈钢Steel  
 环境温度Temperature: -40° C to +85° C

欧洲标准Eropre Stander:  
 250V 32A 0.5~2.5mm<sup>2</sup> (f) 0.5~4.0mm<sup>2</sup> (r)  
 美国标准USA Stander:  
 600V 20A 24-12AWG str/sol  
 中国标准China Stander:  
 450V 32A 0.5~2.5mm<sup>2</sup> (f) 0.5~4.0mm<sup>2</sup> (r)

# 导线连接器 Connector XY222

## 7JJ

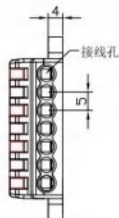
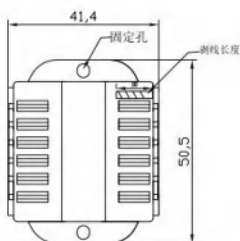
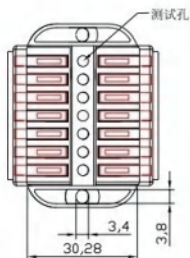

## 8JJ

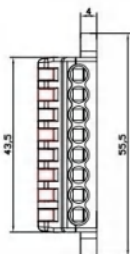
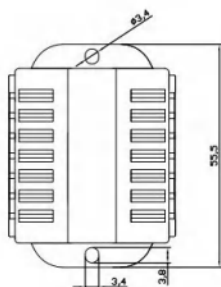
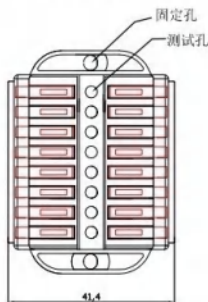

## 9JJ

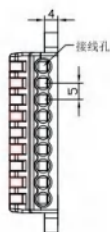
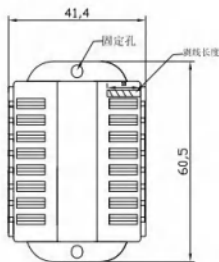
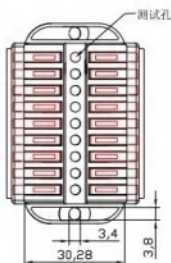

## 10JJ

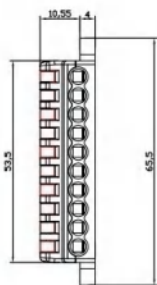
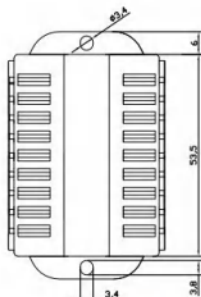

胶壳材质Housing: PA

夹紧件材质Metal Part: 铜Brass

锁线弹片材质Metal: 不锈钢Steel

环境温度Temperature: -40° C to +85° C

欧洲标准Erope Stander:

250V 32A 0.5~2.5mm<sup>2</sup> (f) 0.5~4.0mm<sup>2</sup> (r)

美国标准USA Stander:

600V 20A 24-12AWG str/sol

中国标准China Stander:

450V 32A 0.5~2.5mm<sup>2</sup> (f) 0.5~4.0mm<sup>2</sup> (r)

# 导线连接器 Connector XY222

11JJ

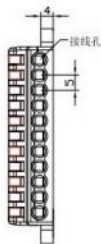
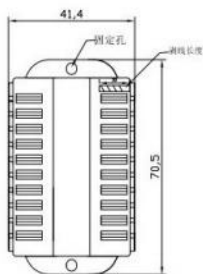
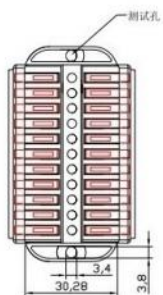

12JJ

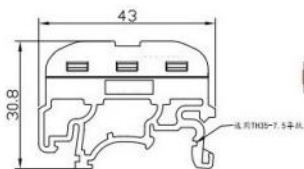
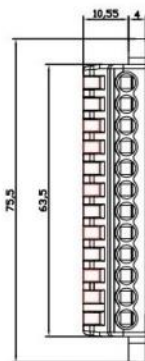
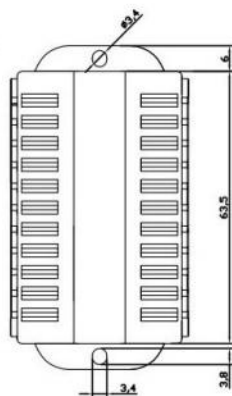
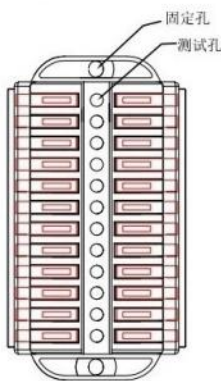

XY222-J 1P

XY222-J 2P

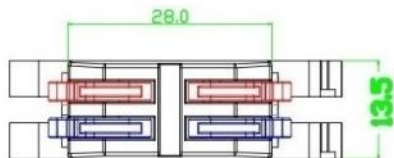

胶壳材质Housing: PA  
 夹件材质Metal Part: 铜Brass  
 锁线弹片材质Metal: 不锈钢Steel  
 环境温度Temperature: -40° C to +85° C

欧洲标准Erope Stander:  
 250V 32A 0.5~2.5mm<sup>2</sup> (f) 0.5~4.0mm<sup>2</sup> (r)  
 美国标准USA Stander:  
 600V 20A 24-12AWG str/sol  
 中国标准China Stander:  
 450V 32A 0.5~2.5mm<sup>2</sup> (f) 0.5~4.0mm<sup>2</sup> (r)

# 导线连接器 Connector XY222

## XY222-J 3P



## XY222-J 4P

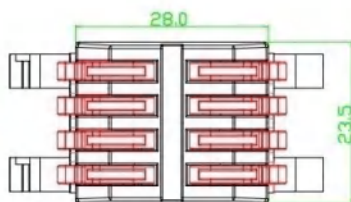

## XY222-J 5P

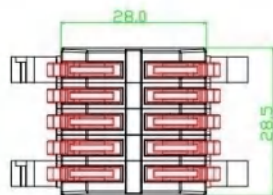

## XY222-J 6P

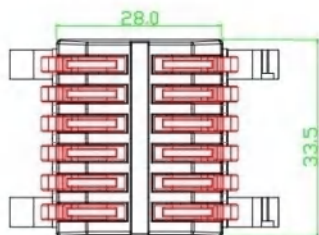

## XY222-J 8P

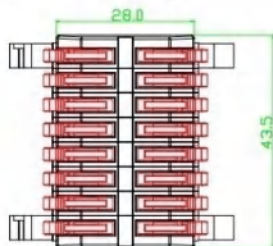

## XY222-J 10P

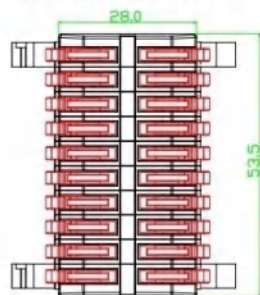

## XY222-J 12P

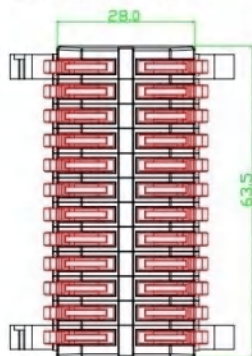

## XY222-J 14P

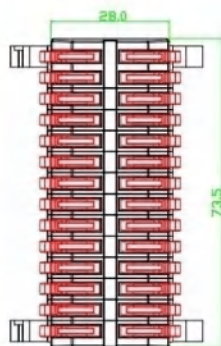

## XY222-J 15P

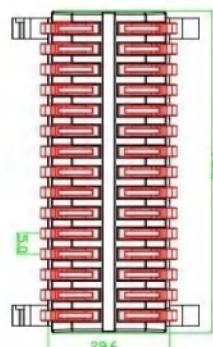

## XY222-J 16P

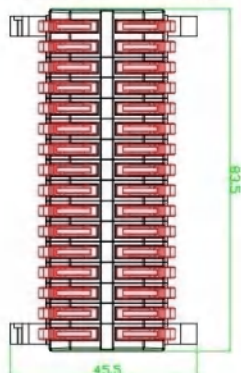

## XY222-J 20P

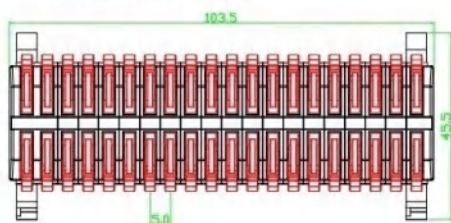

夹零件材质Metal Part: 铜Brass  
 锁线弹片材质Metal: 不锈钢Steel  
 环境温度Temperature:  $-40^{\circ}\text{C}$  to  $+85^{\circ}\text{C}$   
 欧洲标准Europe Stander:  
 250V 32A 0.5~2.5mm<sup>2</sup> (f) 0.5~4.0mm<sup>2</sup> (r)  
 美国标准USA Stander:  
 600V 20A 24-12AWG str/sol  
 中国标准China Stander:  
 450V 32A 0.5~2.5mm<sup>2</sup> (f) 0.5~4.0mm<sup>2</sup> (r)

## 导线连接器 Connector



### 2064

内部电位连接图：串联

series connection



### 2064B

内部电位连接图：并联 paralleling



内部电位连接图：并联 paralleling



NO. : 2P. 3P. 4P. . . . . NP

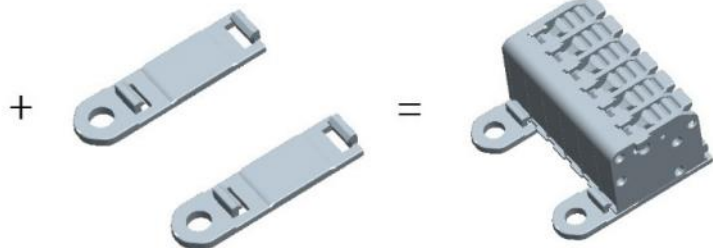
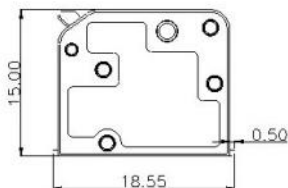
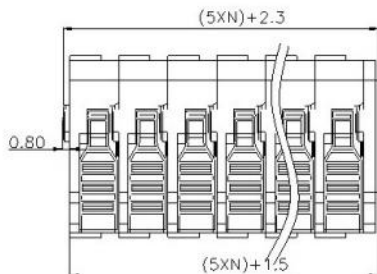

胶壳材质Housing : PA

夹紧件材质Metal Part : 铜Brass

锁线弹片材质Metal : 不锈钢Steel

环境温度Temperature : -40°C to +85°C

欧洲标准Eropre Stander :

250V 32A 0.5~2.5mm<sup>2</sup> ( f ) 0.5~4.0mm<sup>2</sup> ( r )

美国标准USA Stander :

600V 20A 24-12AWG str/sol

中国标准China Stander :

450V 32A 0.5~2.5mm<sup>2</sup> ( f ) 0.5~4.0mm<sup>2</sup> ( r )

# 导线连接器 Connector 2064P

NO. : 1P. 2P... NP

手柄款式一



手柄款式二

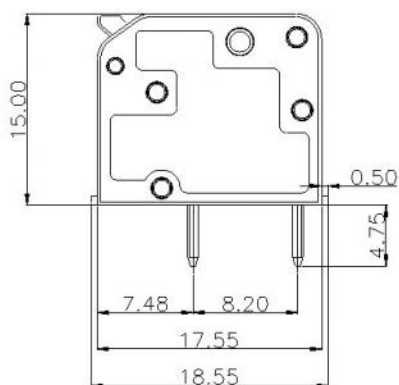
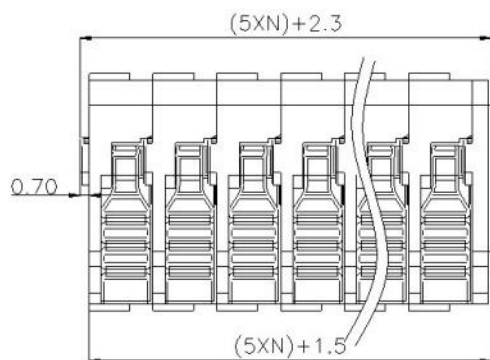

胶壳材质Housing : PA

夹紧件材质Metal Part : 铜Brass

锁线弹片材质Metal : 不锈钢Steel

环境温度Temperature : -40°C to +85°C

欧洲标准Europe Stander :

250V 32A 0.5~2.5mm<sup>2</sup> ( f ) 0.5~4.0mm<sup>2</sup> ( r )

美国标准USA Stander :

600V 20A 24-12AWG str/sol

中国标准China Stander :

450V 32A 0.5~2.5mm<sup>2</sup> ( f ) 0.5~4.0mm<sup>2</sup> ( r )

## 导线连接器 Connector 2064P1

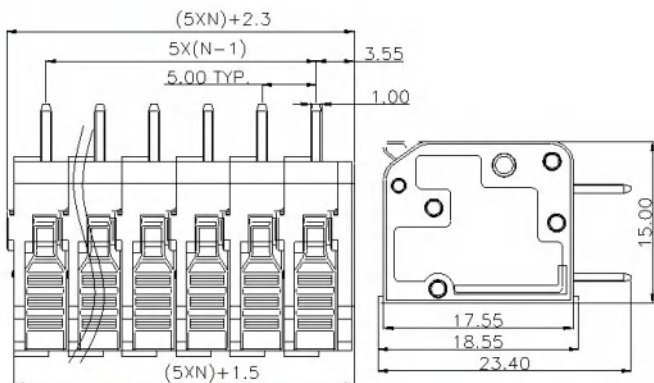

NO. : 1P. 2P. . . NP

胶壳材质Housing : PA

夹零件材质Metal Part : 铜Brass

锁线弹片材质Metal : 不锈钢Steel

环境温度Temperature : -40°C to +85°C

欧洲标准Eropre Stander :

250V 32A 0.5~2.5mm<sup>2</sup> ( f ) 0.5~4.0mm<sup>2</sup> ( r )

美国标准USA Stander :

600V 20A 24-12AWG str/sol

中国标准China Stander :

450V 32A 0.5~2.5mm<sup>2</sup> ( f ) 0.5~4.0mm<sup>2</sup> ( r )

## 导线连接器 Connector 2064A

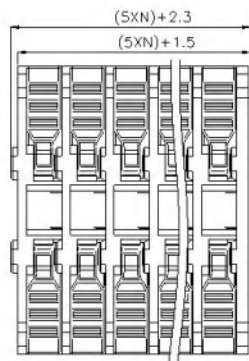
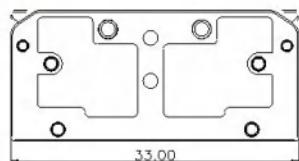

NO. : 1P. 2P. . . NP

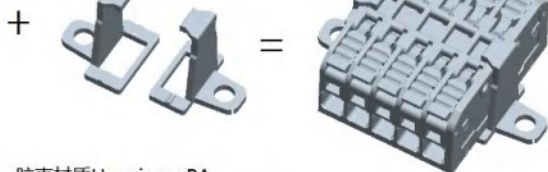

欧洲标准Eropre Stander :

250V 32A 0.5~2.5mm<sup>2</sup> ( f ) 0.5~4.0mm<sup>2</sup> ( r )

美国标准USA Stander :

600V 20A 24-12AWG str/sol

中国标准China Stander :

450V 32A 0.5~2.5mm<sup>2</sup> ( f ) 0.5~4.0mm<sup>2</sup> ( r )

胶壳材质Housing : PA

夹零件材质Metal Part : 铜Brass

锁线弹片材质Metal : 不锈钢Steel

环境温度Temperature : -40°C to +85°C

# 导线连接器 Connector 2064A



1-2P



1-3P



2-4P



2-6P



3-6P

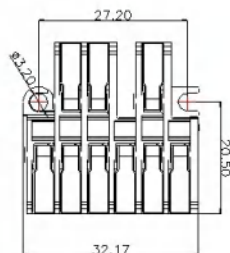
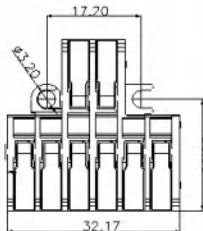
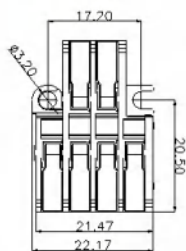
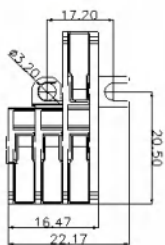
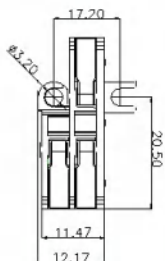

3-9P

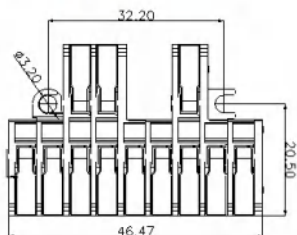

FTB

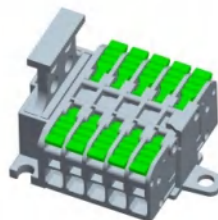
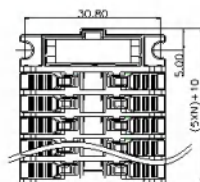

FTB J

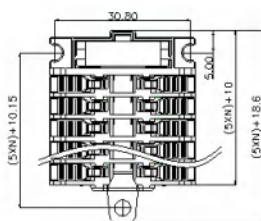

胶壳材质Housing : PA

夹紧件材质Metal Part : 铜Brass

锁线弹片材质Metal : 不锈钢Steel

环境温度Temperature : -40°C to +85°C

欧洲标准Eropre Stander :

250V 32A 0.5~2.5mm<sup>2</sup> (f) 0.5~4.0mm<sup>2</sup> (r)

美国标准USA Stander :

600V 20A 24-12AWG str/sol

中国标准China Stander :

450V 32A 0.5~2.5mm<sup>2</sup> (f) 0.5~4.0mm<sup>2</sup> (r)

# 导线连接器 Connector 2064D

NO. : 1P. 2P. . . NP

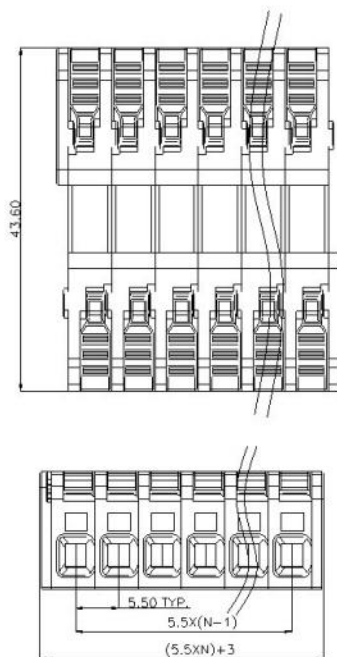

NO. : 1-2P, 1-3P, 2-4P, 2-6P. .

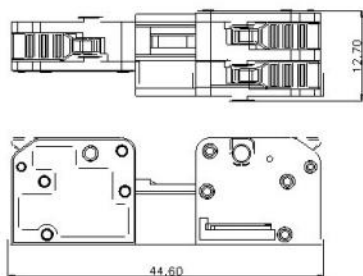

胶壳材质Housing : PA

夹紧件材质Metal Part : 铜Brass

锁线弹片材质Metal : 不锈钢Steel

环境温度Temperature : -40°C to +85°C

欧洲标准Erope Stander :

250V 32A 0.5~2.5mm<sup>2</sup> ( f ) 0.5~4.0mm<sup>2</sup> ( r )

美国标准USA Stander :

600V 20A 24-12AWG str/sol

中国标准China Stander :

450V 32A 0.5~2.5mm<sup>2</sup> ( f ) 0.5~4.0mm<sup>2</sup> ( r )

# 导线连接器 Connector 222



2P



3P



4P

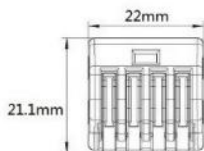
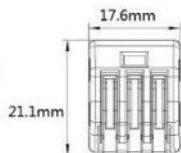
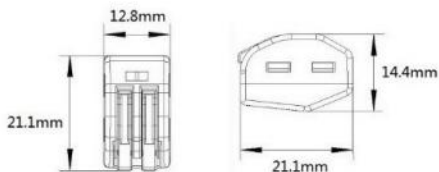

5P



8P

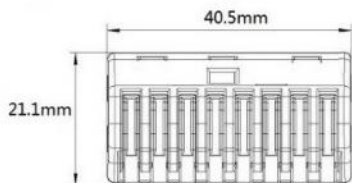
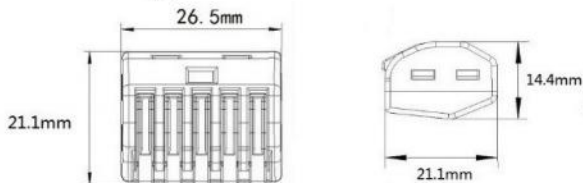

Connection mode (2 seconds quick-connection)

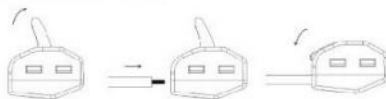

胶壳材质Housing: PA

夹紧件材质Metal Part: 铜brass

锁线弹片材质Metal; 不锈钢steel

环境温度temperature: -40°C to +85°C

欧洲标准Erope Stander:

250V 32A 0.5~2.5mm<sup>2</sup> (f) 0.5~4mm<sup>2</sup> (r)

美国标准USA Stander:

600V 20A 24-12str/sol

中国标准China Stander:

450V 32A 0.5~2.5mm<sup>2</sup> (f) 0.5~4mm<sup>2</sup> (r)



## 导线连接器 Connector 935

2JJ 3JJ 4JJ 5JJ 2P 3P 4P 5P

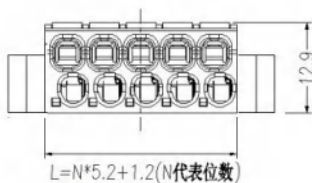
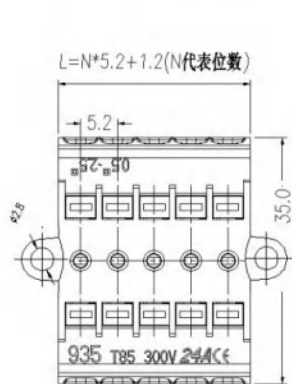
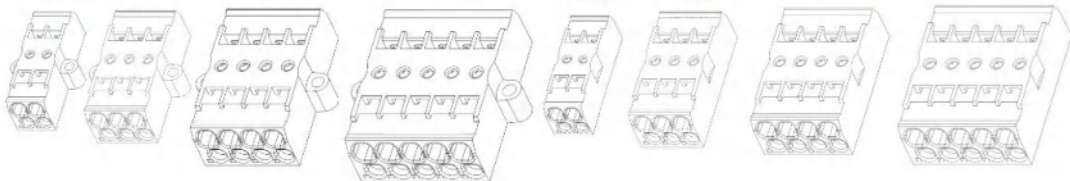

胶壳材质Housing : PA  
 五金材质Metal Material : 铜Brass  
 环境温度Temperature : -40°C to +85°C  
 欧洲标准Eropre Stander : 450V 24A 0.5~2.5mm<sup>2</sup>  
 美国标准USA Stander : 300V 24A 20-12AWG  
 中国标准China Stander : 450V 24A 0.5~2.5mm<sup>2</sup>

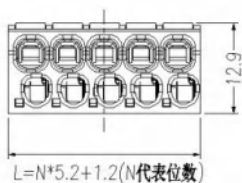
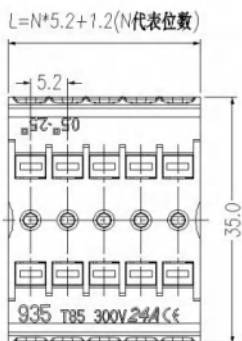

## 导线连接器 Connector XY1

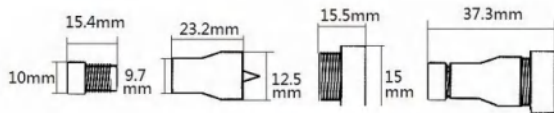

**NO CRIMPING**  
**NO TOOLS NEEDED**

接线范围Wiring  
 Capacity: 14/16/  
 18/20AWG

接线范围Wiring  
 Capacity:  
 12/14AWG

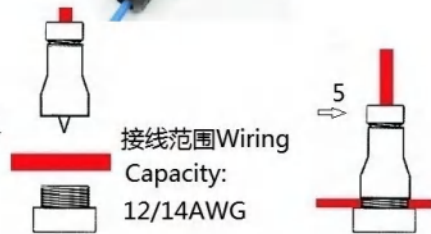
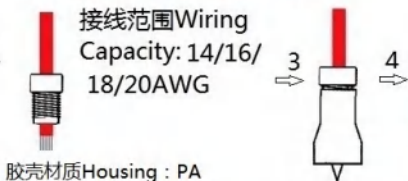
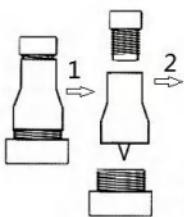

胶壳材质Housing : PA  
 五金材质Metal Material : 铜Brass  
 环境温度Temperature : -40°C to +85°C

## SMD2065

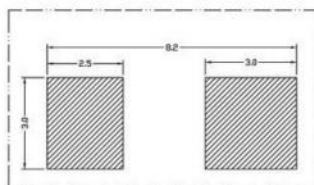
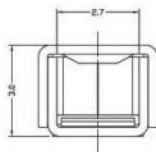
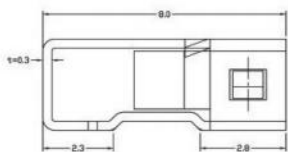
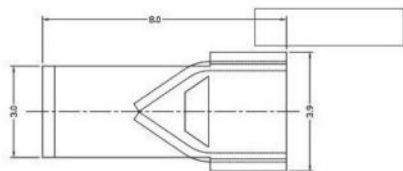

2065 LAYOUT

五金材质Metal Material : 铜Brass

环境温度Temperature : -40°C to +105°C

欧洲标准Eupro Stander : 250V 12A 0.5~1.5mm<sup>2</sup>

美国标准USA Stander : 600V 12A 20-16AWG

中国标准China Stander : 250V 12A 0.5~1.5mm<sup>2</sup>

## SMD2055

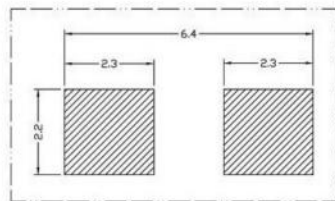
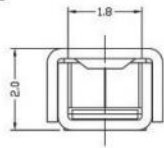
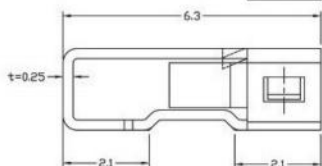
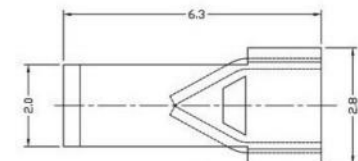
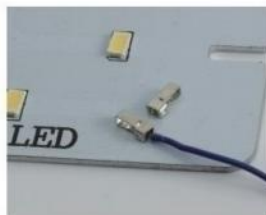

2055 LAYOUT

五金材质Metal Material : 铜Brass

环境温度Temperature : -40°C to +105°C

欧洲标准Eupro Stander :

250V 9A 0.5~0.75mm<sup>2</sup>

美国标准USA Stander :

600V 9A 22-18AWG

中国标准China Stander :

250V 9A 0.5~0.75mm<sup>2</sup>

# 线路板专用 Dedicated to circuit boards P01

产品型号Type：带焊With Solder P01

产品位数NO.：2P, 3P, 4P, 5P

产品型号Type：不带焊Without Solder P01-S

产品位数NO.：2P, 3P, 4P, 5P



胶壳材质Housing：PA

夹紧件材质Metal Part：铜Brass

锁线弹片材质Metal：不锈钢Steel

环境温度Temperature：-40°C to +85°C

欧洲标准Eropre Stander：450V 10A/16A 0.5~2.5mm<sup>2</sup>

美国标准USA Stander：300V 10A 20-14AWG

中国标准China Stander：250V 10A 0.5~2.5mm<sup>2</sup>



带针焊 With Solder



不带针焊 Without Solder

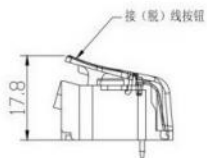
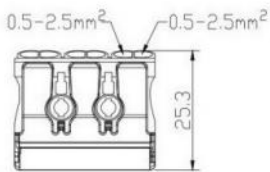
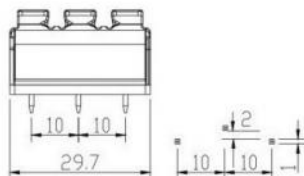
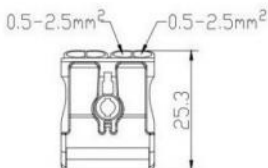
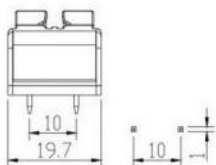

接线方式 (2秒快速接线) Connection mode(2 seconds quick-connection)

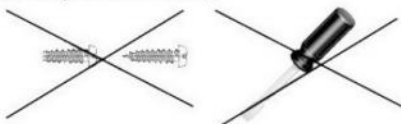
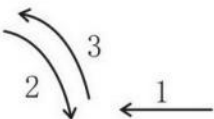

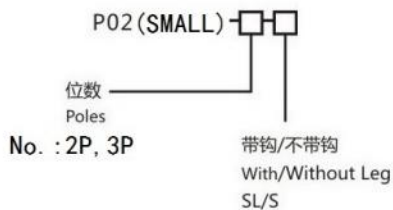

胶壳材质Housing : PA

夹零件材质Metal Part : 铜Brass

锁线弹片材质Metal : 不锈钢Steel

环境温度Temperature : -40°C to +85°C

欧洲标准Europe Stander : 450V 16A 0.5~2.5mm<sup>2</sup>

美国标准USA Stander : 600V 16A 20-14AWG

中国标准China Stander : 450V 16A 0.5~2.5mm<sup>2</sup>

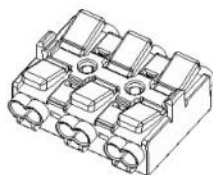
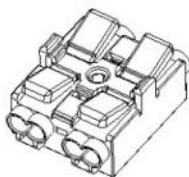

不带钩S

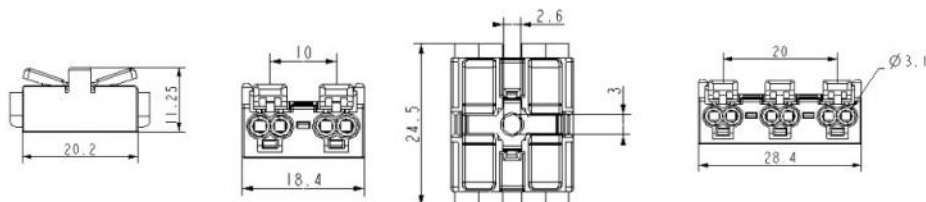

带钩SL

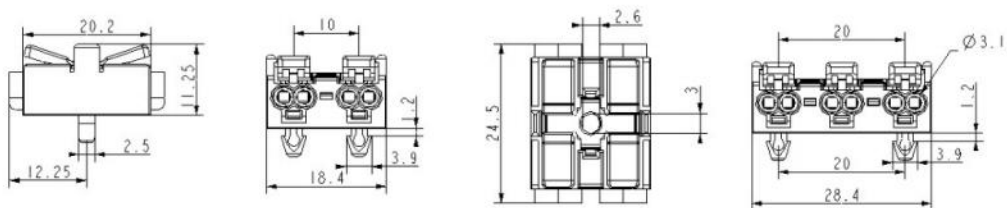



胶壳材质Housing : PA

夹紧件材质Metal Part : 铜Brass

锁线弹片材质Metal : 不锈钢Steel

环境温度Temperature : -40°C to +85°C

欧洲标准Euro Pre Stander : 450V 16A 0.5~2.5mm<sup>2</sup>

美国标准USA Stander : 600V 16A 20-14AWG

中国标准China Stander : 450V 16A 0.5~2.5mm<sup>2</sup>

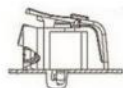
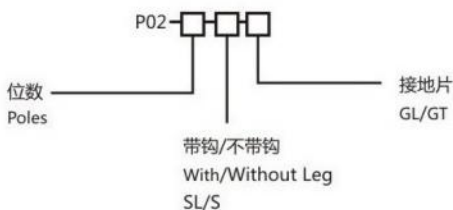
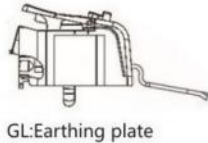
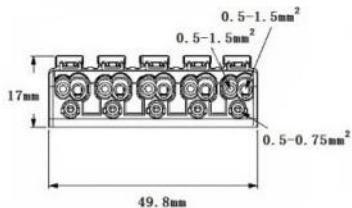
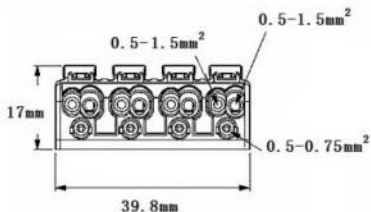
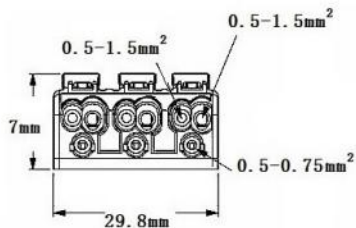
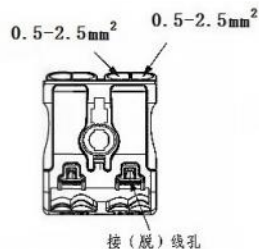
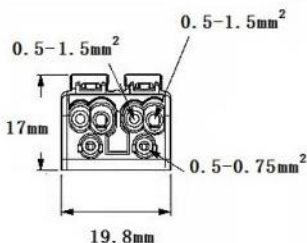
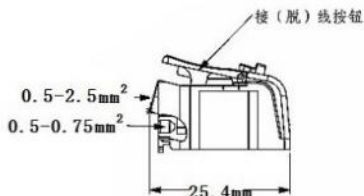

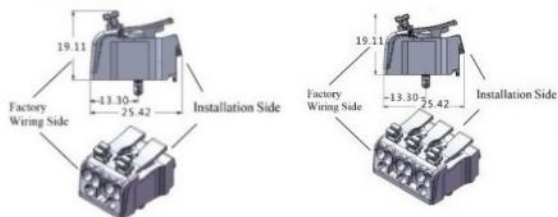

胶壳材质Housing : PA

夹件材质Metal Part : 铜Brass

锁线弹片材质Metal : 不锈钢Steel

环境温度Temperature : -40°C to +85°C

欧洲标准Erope Stander : 450V 16A 0.5~2.5mm<sup>2</sup>

美国标准USA Stander : 600V 16A 20-14AWG

中国标准China Stander : 450V 16A 0.5~2.5mm<sup>2</sup>

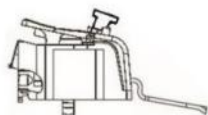
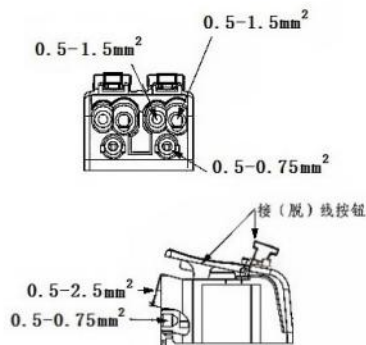
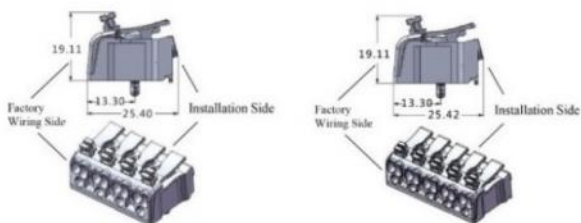

GL:Earthing plate



Without Leg

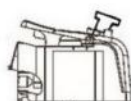

With Leg



GT:Quick-Earthing snap

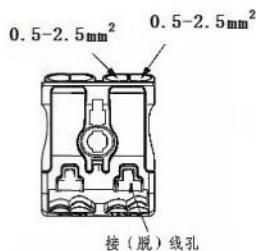
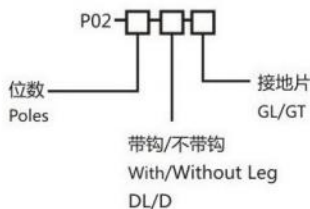

# 照明设备接线端子 Luminaire disconnect XYGST18

产品接口interfaced : 一进一出 one in and one out

产品型号Type : XYGST18-C

产品位数No : 2P:XYGST18-C2P

3P:XYGST18-C3P

4P:XYGST18-C4P

5P:XYGST18-C5P

产品接口interfaced : 一进二出 one in and two out

产品型号Type : XYGST18-T

产品位数No : 2P:XYGST18-T2P

3P:XYGST18-T3P

4P:XYGST18-T4P

5P:XYGST18-T5P

产品接口interfaced : 二进二出 two in and two out

产品型号Type : XYGST18-TC

产品位数No : 2P:XYGST18-TC2P

3P:XYGST18-TC3P

4P:XYGST18-TC4P

5P:XYGST18-TC5P



胶壳材质Housing : PC

夹零件材质Metal Part : 铜Brass

锁线弹片材质Metal : 不锈钢Steel

环境温度Temperature : -40°C to +85°C

欧洲标准Euro Pre Stander : 450V 16A 0.5~2.5mm<sup>2</sup>

美国标准USA Stander : 600V 16A 20-14AWG

中国标准China Stander : 450V 16A 0.5~2.5mm<sup>2</sup>

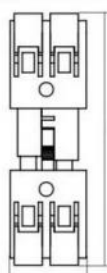

19.4mm

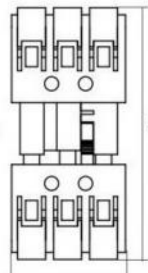

28.4mm

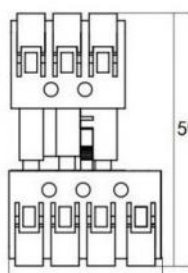

37.4mm

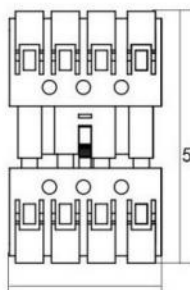

37.4mm

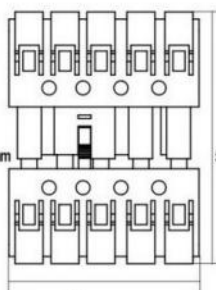

48mm

接线方式 (2秒快速接线)

Connection mode (2 seconds quick-connection)

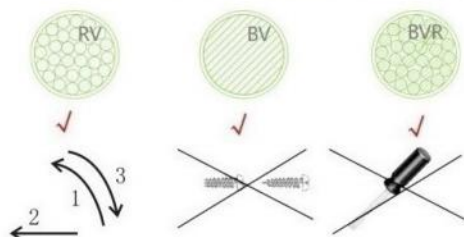

# 导线连接器 Connector

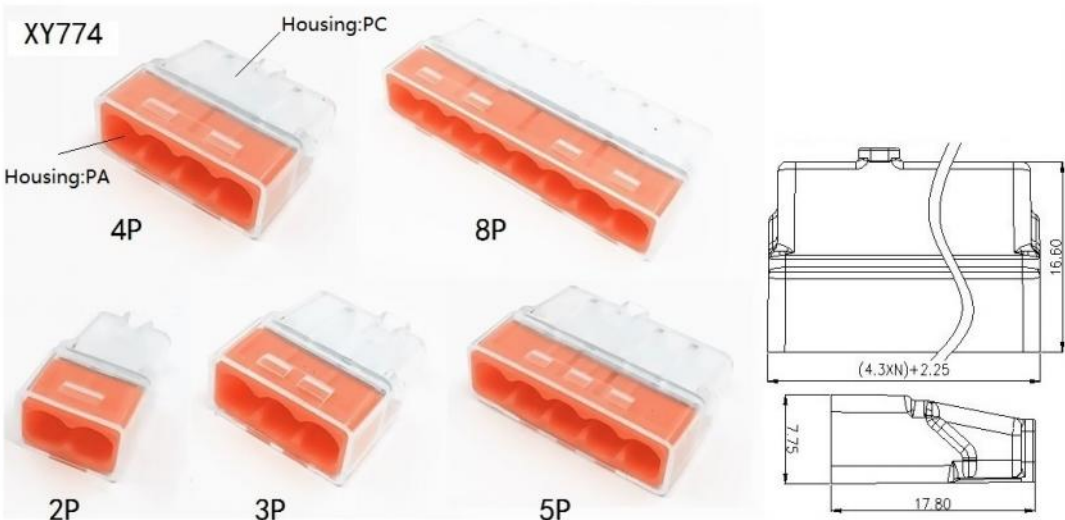

胶壳材质Housing : PA,PC

夹紧件材质Metal Part : 铜Brass

锁线弹片材质Metal : 不锈钢Steel

环境温度Temperature : -40°C to +85°C

欧洲标准Eropre Stander : 450V 32A 0.2~4.0mm<sup>2</sup>(Sol) 0.34~2.5mm<sup>2</sup> ( Str)

美国标准USA Stander : 600V 35A 20-12AWG

中国标准China Stander : 450V 24A 0.5~2.5mm<sup>2</sup> 0.5~2.5mm<sup>2</sup>

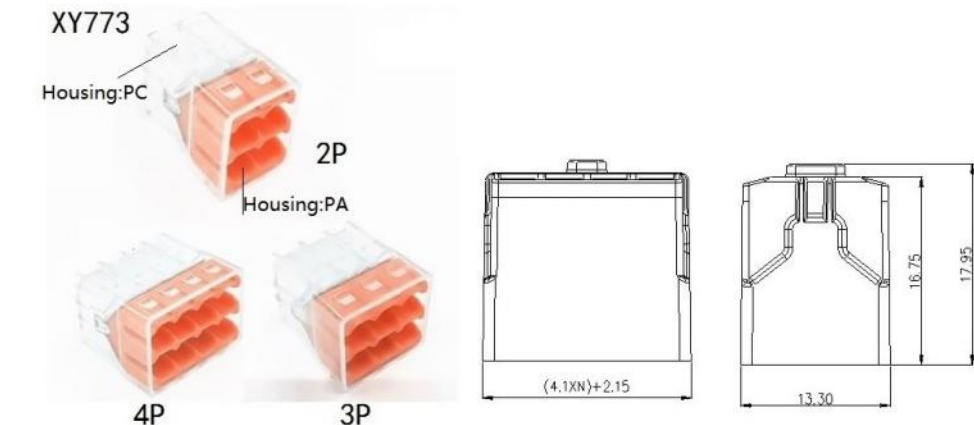

胶壳材质Housing : PA,PC

夹紧件材质Metal Part : 铜Brass

锁线弹片材质Metal : 不锈钢Steel

环境温度Temperature : -40°C to +85°C

欧洲标准Eropre Stander : 450V 32A 0.2~4.0mm<sup>2</sup>(Sol) 0.34~2.5mm<sup>2</sup> ( Str)

美国标准USA Stander : 600V 35A 20-12AWG

中国标准China Stander : 450V 24A 0.5~2.5mm<sup>2</sup> 0.5~2.5mm<sup>2</sup>

# PCB端子

XY235  位数Pin

间距Pitch 5mm  
间距Pitch 7.5mm  
间距Pitch 10mm

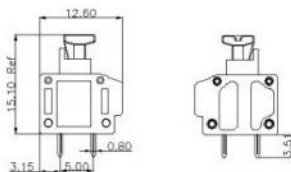

胶壳材质Housing : PA  
五金材质Metal Material : 铜合金Copper alloy  
环境温度Temperature : -40°C to +85°C  
欧洲标准Eropre Stander :  
250V 10A 0.5~1.5mm<sup>2</sup>  
美国标准USA Stander :  
300V 10A 22-14AWG str/sof  
中国标准China Stander :  
250V 10A 0.5~1.5mm<sup>2</sup>

间距Pitch 5mm

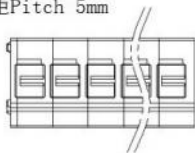

N=产品位数 Product Pin

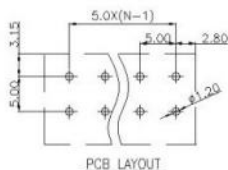
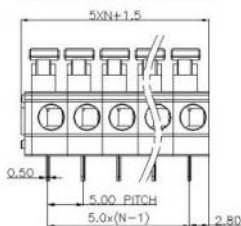

间距Pitch 7.5mm

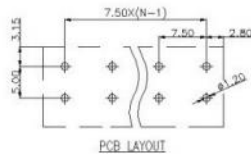
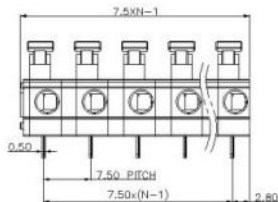

间距Pitch 10mm

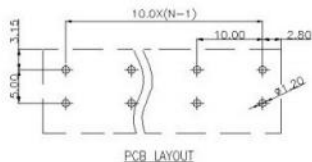
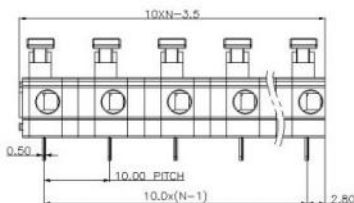

# PCB端子

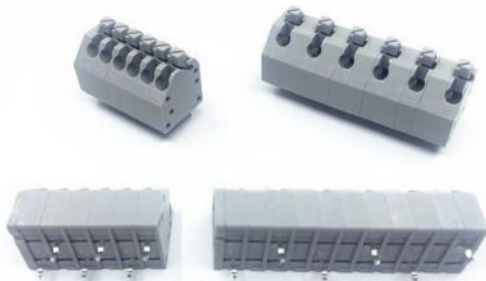
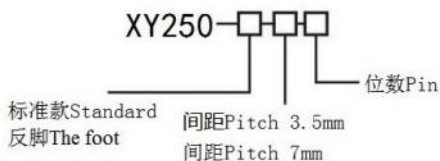

间距Pitch 3.5mm  
N=产品位数 Product Pin

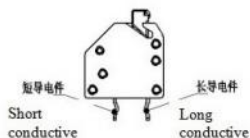
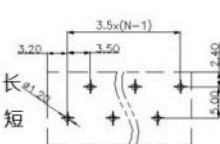
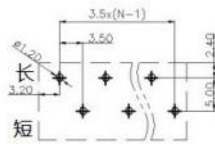
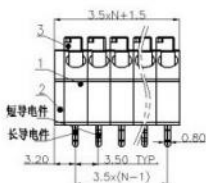
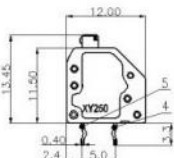
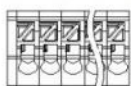

标准款Standard

反脚The foot

胶壳材质Housing : PA

五金材质Metal Material : 铜合金

Copper alloy

环境温度Temperature : -40°C to +85°C

欧洲标准Eropre Stander :

250V 5A 0.5~1.5mm<sup>2</sup>

美国标准USA Stander :

300V 8A 22-14AWG sol 24-16AWG Str

中国标准China Stander :

250V 5A 0.5~1.5mm<sup>2</sup>

间距Pitch 7mm

N=产品位数 Product Pin

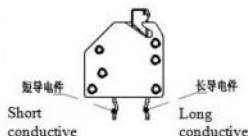
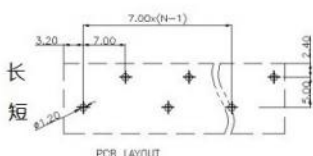
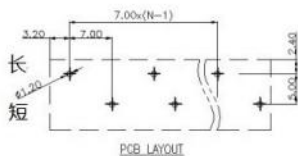
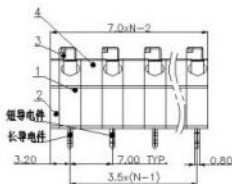
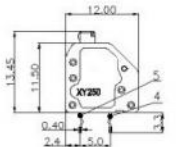
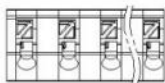

标准款Standard

反脚The foot

# IP68免螺丝防水连接器IP68

Waterproof connector(without SCREW)



Φ 8 OD: 6-8mm

Φ 9 OD: 7-9mm

Φ 12 OD: 9-12mm

XY222-IP68-T

位数NO. : 2P,3P

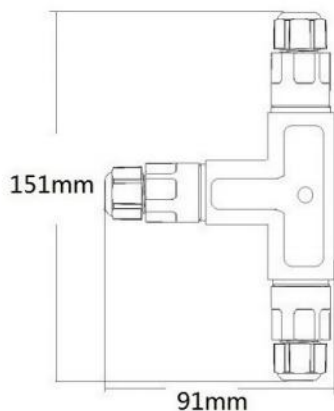

Φ 8 OD: 6-8mm

Φ 9 OD: 7-9mm

Φ 12 OD: 9-12mm

XY222-IP68-X

位数NO. : 2P,3P

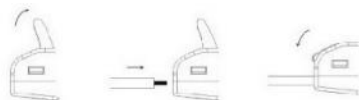
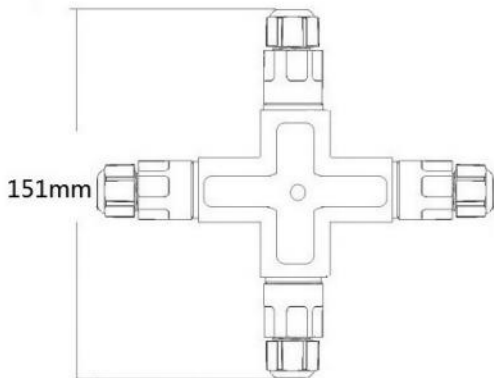

胶壳材质Housing : PA

夹零件材质Metal Part : 铜Brass

铜线弹片材质Metal : 不锈钢Steel

防水密封圈Waterproof O-Ring : 硅胶Silicon

环境温度Temperature : -40°C to +85°C

欧洲标准Eropre Stander :

450V 16A 0.5-4.0mm<sup>2</sup>

美国标准USA Stander :

300V 20A 24-12AWG

中国标准China Stander :

450V 32A 0.5-4.0mm<sup>2</sup>

# IP68免螺丝防水连接器

Waterproof connector(without SCREW)

XY222 (I) - IP68  
NO. : 2P,3P

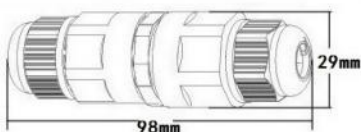

φ8 OD: 6-8mm

φ9 OD: 7-9mm

φ12 OD: 9-12mm

欧洲标准Europe Stander :  
450V 16A 0.5-4.0mm<sup>2</sup>  
美国标准USA Stander :  
300V 20A 24-12AWG  
中国标准China Stander :  
450V 32A 0.5-4.0mm<sup>2</sup>

XY222 (I1) - IP68  
NO. : 2P,3P

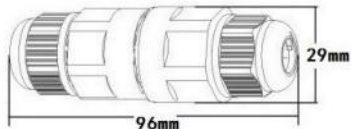

手柄颜色: 橘色 (另有蓝/黄/棕)  
HANDLE COLOR: Regular Orange,  
other blue/yellow/brown  
胶壳材质Housing : PA  
夹紧件材质Metal Part : 铜Brass  
锁线弹片材质Metal : 不锈钢Steel  
防水密封圈Waterproof O-Ring : 硅胶Silicon  
环境温度Temperature : -40°C to +85°C

XY222-IP68-Y

1-2



位数NO. : 2P  
2X0.5mm<sup>2</sup>  
2X0.75mm<sup>2</sup>  
2X1.0mm<sup>2</sup>

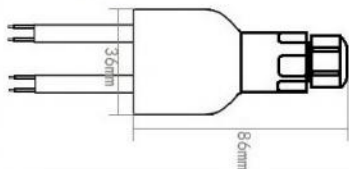

φ8 OD: 6-8mm

φ9 OD: 7-9mm

φ12 OD: 9-12mm

XY222-IP68-Y

1-3



位数NO. : 2P  
2X0.5mm<sup>2</sup>  
2X0.75mm<sup>2</sup>  
2X1.0mm<sup>2</sup>

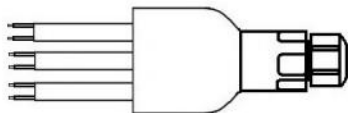

# IP68免螺丝防水连接器IP68

Waterproof connector(without SCREW)

XY221-IP68-T

NO. : 3P

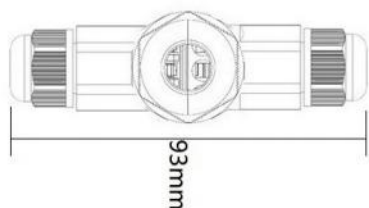

Φ 8 OD: 6-8mm

Φ 9 OD: 7-9mm

Φ 12 OD: 9-12mm

XY221-IP68-H

NO. : 3P

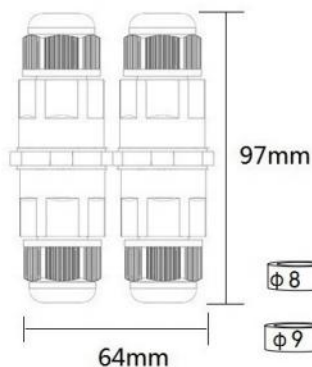

Φ 8 OD: 6-8mm

Φ 9 OD: 7-9mm

Φ 12 OD: 9-12mm

胶壳材质Housing : PA

夹件材质Metal Part : 铜Brass

锁线弹片材质Metal : 不锈钢Steel

防水密封圈Waterproof O-Ring : 硅胶Silicon

环境温度Temperature : -40°C to +85°C

欧洲标准Erope Stander : 250V 10A 0.5~2.5mm<sup>2</sup>

美国标准USA Stander : 300V 10A 24-14AWG

中国标准China Stander : 250V 10A 0.5~2.5mm<sup>2</sup>

# IP68免螺丝防水连接器IP68

Waterproof connector(without SCREW)



XYW221  
NO. : 3P

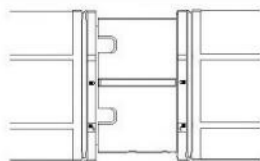
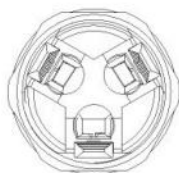

已锁

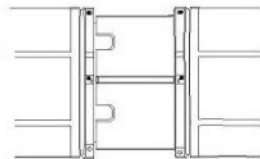

未锁

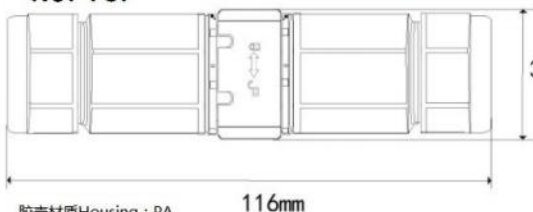

φ8 OD: 6-8mm

31mm φ9 OD: 7-9mm

φ12 OD: 9-12mm

胶壳材质Housing : PA

夹紧件材质Metal Part : 铜Brass

锁线弹片材质Metal : 不锈钢Steel

防水密封圈Waterproof O-Ring : 硅胶Silicon

环境温度Temperature : -40°C to +85°C

欧洲标准Eropre Stander : 250V 16A 0.5~2.5mm<sup>2</sup>

美国标准USA Stander : 600V 20A 24-14AWG

中国标准China Stander : 250V 16A 0.5~2.5mm<sup>2</sup>



φ8 OD: 6-8mm

φ9 OD: 7-9mm

φ12 OD: 9-12mm

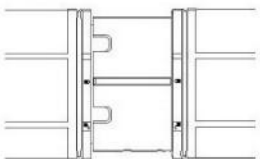

已锁



未锁

XYW222

NO. : 5P



胶壳材质Housing : PA

夹紧件材质Metal Part : 铜Brass

锁线弹片材质Metal : 不锈钢Steel

防水密封圈Waterproof O-Ring : 硅胶Silicon

环境温度Temperature : -40°C to +85°C

欧洲标准Eropre Stander : 250V 16A 0.5~2.5mm<sup>2</sup>

美国标准USA Stander : 600V 20A 24-14AWG

中国标准China Stander : 250V 16A 0.5~2.5mm<sup>2</sup>

# IP68免螺丝连接器IP68

Waterproof connector(without SCREW)

XY2064 (I) – IP68 – W01



No. : 2P 3P

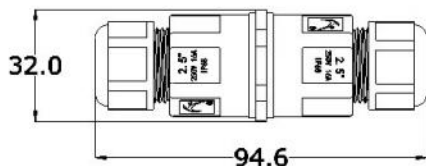

胶壳材质Housing : PA

夹零件材质Metal Part : 铜Brass

锁线弹片材质Metal : 不锈钢Steel

防水密封圈Waterproof O-Ring : 硅胶Silicon

环境温度Temperature : -40°C to +85°C

$\phi 8$  OD: 6-8mm

$\phi 9$  OD: 7-9mm

$\phi 12$  OD: 9-12mm

XY2064 (I) – IP68 – B01



No. : 3P

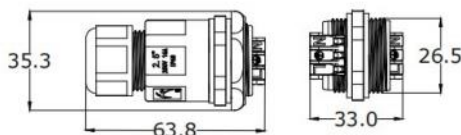

欧洲标准Euprope Stander : 250V 16A 0.5~2.5mm<sup>2</sup>

美国标准USA Stander : 600V 20A 24-14AWG

中国标准China Stander : 250V 16A 0.5~2.5mm<sup>2</sup>

XY10-W01 NO. : 2P

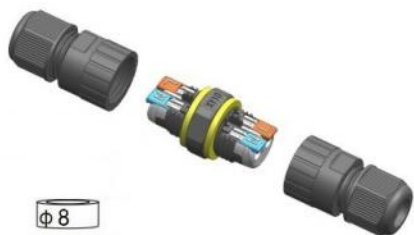

$\phi 8$   
OD: 6-8mm

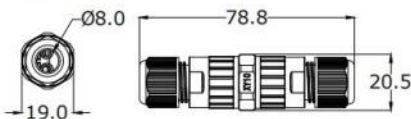

胶壳材质Housing : PA

夹零件材质Metal Part : 铜Brass

锁线弹片材质Metal : 不锈钢Steel

防水密封圈Waterproof O-Ring : 硅胶Silicon

环境温度Temperature : -40°C to +85°C

XY10-B01 No. : 2P



$\phi 8$  OD: 6-8mm  
 $\phi 8.0$   
19.0

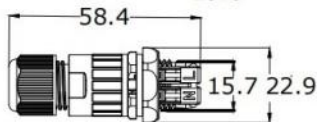

欧洲标准Euprope Stander : 250V 16A 0.5~2.5mm<sup>2</sup>

美国标准USA Stander : 600V 20A 24-14AWG

中国标准China Stander : 250V 16A 0.5~2.5mm<sup>2</sup>

# IP68免螺丝防水连接器IP68

Waterproof connector(without SCREW)

XY17-W01 NO. :3P



XY17-B02(MF-M18)  
NO. :3P

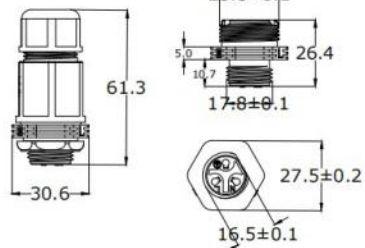

胶壳材质Housing : PA

夹零件材质Metal Part : 铜Brass

锁线弹片材质Metal : 不锈钢Steel

防水密封圈Waterproof O-Ring : 硅胶Silicon

环境温度Temperature : -40°C to +85°C

欧洲标准Europe Stander : 250V 16A 0.5~2.5mm<sup>2</sup>

美国标准USA Stander : 600V 20A 24-14AWG

中国标准China Stander : 250V 16A 0.5~2.5mm<sup>2</sup>

XY17-B01 NO. :3P

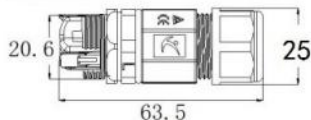

XY17-B04 NO. :3P



(C-M16) 板螺纹M16X1.5

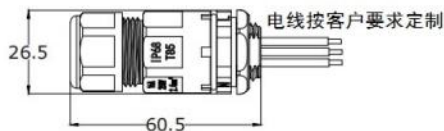

(C-M18) 板螺纹M18X1.5

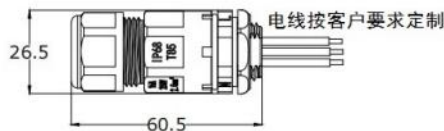

(C-PG16) 板螺纹PG16

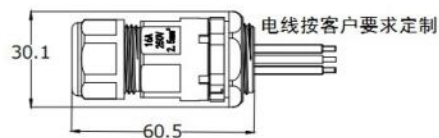

φ8 OD:6-8mm    φ9 OD:7-9mm    φ12 OD:9-12mm

# IP68免螺丝防水连接器IP68

Waterproof connector(without SCREW)

XY17-B03 (MF-M3)

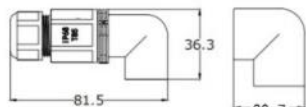

过线直径 $\varnothing 8.0$  螺丝孔间距11.0



$\varnothing 8$  OD: 6-8mm

$\varnothing 9$  OD: 7-9mm

$\varnothing 12$  OD: 9-12mm

XY17-B03 (MF-M14)

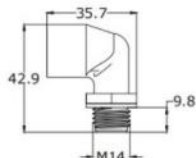
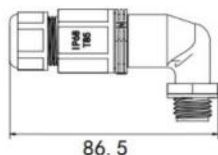

欧洲标准Euro Stander : 250V 16A 0.5~2.5mm<sup>2</sup>

美国标准USA Stander : 600V 20A 24-14AWG

中国标准China Stander : 250V 16A 0.5~2.5mm<sup>2</sup>

胶壳材质Housing : PA

夹零件材质Metal Part : 铜Brass

锁线弹片材质Metal : 不锈钢Steel

防水密封圈Waterproof O-Ring : 硅胶Silicon

环境温度Temperature : -40°C to +85°C

XYX22(MF) NO. : 3P

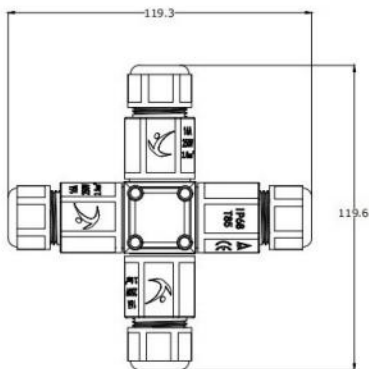

胶壳材质Housing : PA

夹零件材质Metal Part : 铜Brass

锁线弹片材质Metal : 不锈钢Steel

防水密封圈Waterproof O-Ring : 硅胶Silicon

环境温度Temperature : -40°C to +85°C

欧洲标准Euro Stander : 250V 16A 0.5~2.5mm<sup>2</sup>

美国标准USA Stander : 600V 20A 24-14AWG

中国标准China Stander : 250V 16A 0.5~2.5mm<sup>2</sup>

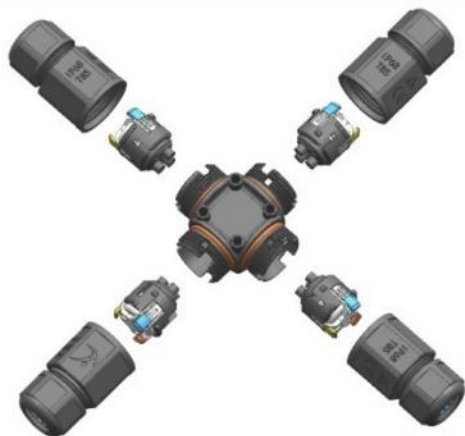
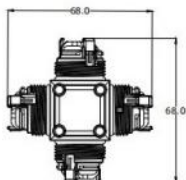

$\varnothing 8$  OD: 6-8mm

$\varnothing 9$  OD: 7-9mm

$\varnothing 12$  OD: 9-12mm

# IP68免螺丝防水连接器IP68

Waterproof connector(without SCREW)

XYT22 NO. :3P

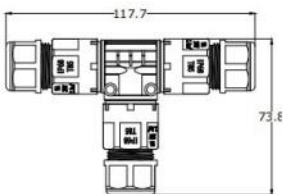
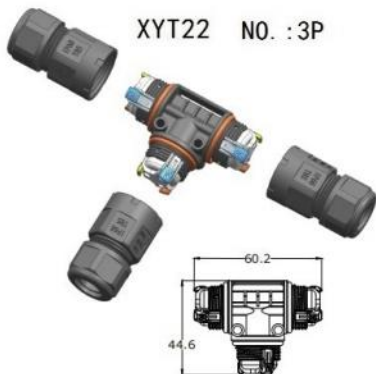

Φ 8 OD: 6-8mm

Φ 9 OD: 7-9mm

Φ 12 OD: 9-12mm

夹紧件材质Metal Part : 铜Brass

锁线弹片材质Metal : 不锈钢Steel

防水密封圈Waterproof O-Ring : 硅胶Silicon

环境温度Temperature : -40°C to +85°C

欧洲标准Europe Stander : 250V 16A 0.5~2.5mm<sup>2</sup>

美国标准USA Stander : 600V 20A 24-14AWG

中国标准China Stander : 250V 16A 0.5~2.5mm<sup>2</sup>

XYT22(MF) NO. :3P



Φ 8 OD: 6-8mm

Φ 9 OD: 7-9mm

Φ 12 OD: 9-12mm

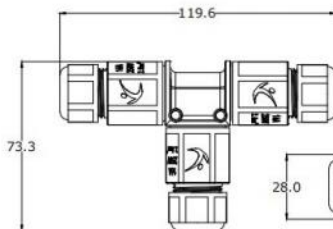

夹紧件材质Metal Part : 铜Brass

锁线弹片材质Metal : 不锈钢Steel

防水密封圈Waterproof O-Ring : 硅胶Silicon

环境温度Temperature : -40°C to +85°C

欧洲标准Europe Stander : 250V 16A 0.5~2.5mm<sup>2</sup>

美国标准USA Stander : 600V 20A 24-14AWG

中国标准China Stander : 250V 16A 0.5~2.5mm<sup>2</sup>

# IP68免螺丝防水连接器IP68

Waterproof connector(without SCREW)

XY22-W01 NO. :3P

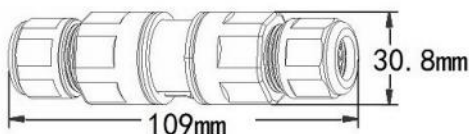

XY22-B01 NO. :3P



XY22M-B01 NO. :3P



防尘帽XY01 Cover

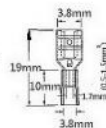
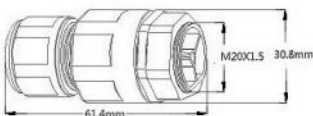
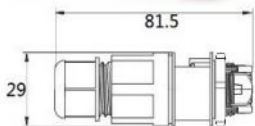

胶壳材质Housing : PA

夹紧件材质Metal Part : 铜Brass

锁线弹片材质Metal : 不锈钢Steel

防水密封胶Waterproof O-Ring : 硅胶Silicon

欧洲标准Europe Stander :

250V 16A 0.5~2.5mm<sup>2</sup>

美国标准USA Stander :

600V 20A 24-14AWG

中国标准China Stander :

Φ8 OD:6-8mm

Φ9 OD:7-9mm



XY21-W01

NO. :5P



XY21-B01

NO. :5P

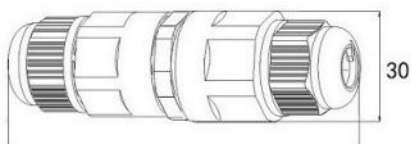

98

Φ8 OD:6-8mm

Φ9 OD:7-9mm

Φ12 OD:9-12mm

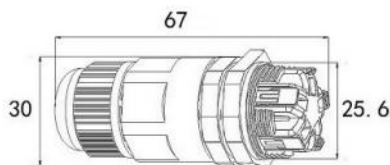

# IP68免螺丝防水连接器IP68 + SLIDE SWITCH

Waterproof connector(without SCREW)

XYP02+K: 2P

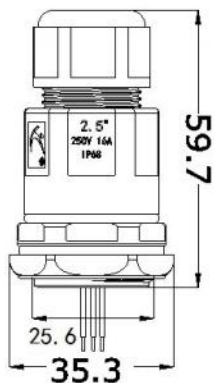

XYP02+K: 3P



$\phi 8$  OD: 6-8mm     $\phi 9$  OD: 7-9mm     $\phi 12$  OD: 9-12mm

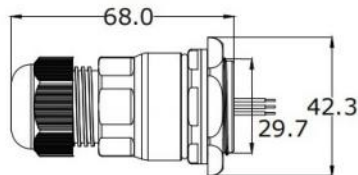

k: 0P

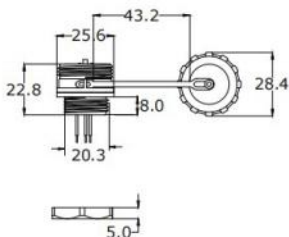

开关: 0.3A DC50V

一档: 黄灯亮

二档: 黄灯与白灯亮

三档: 白灯亮

胶壳材质Housing: PA

夹零件材质Metal Part: 铜Brass

钎线弹片材质Metal: 不锈钢Steel

防水密封圈Waterproof O-Ring: 硅胶Silicon

环境温度Temperature: -40°C to +85°C

欧洲标准Eropre Stander: 250V 16A 0.5-2.5mm<sup>2</sup>

美国标准USA Stander: 600V 20A 24-14AWG

中国标准China Stander: 250V 16A 0.5-2.5mm<sup>2</sup>

# IP68免螺丝防水连接器IP68

Waterproof connector(without SCREW)

XYP02 NO. :2P

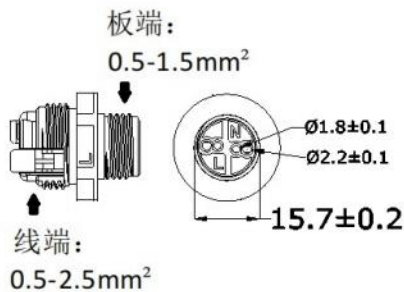
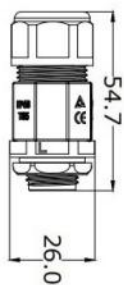

Φ8 OD: 6-8mm    Φ9 OD: 7-9mm    Φ12 OD: 9-12mm

XYP02 NO. :3P

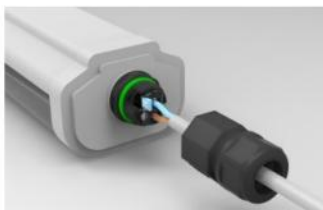
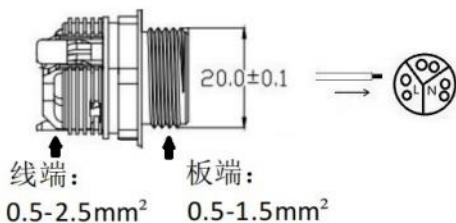
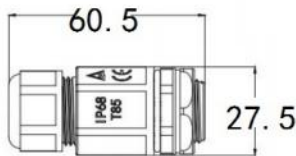

胶壳材质Housing : PA  
 夹零件材质Metal Part : 铜Brass  
 铆线弹片材质Metal : 不锈钢Steel  
 防水密封圈Waterproof O-Ring : 硅胶Silicon  
 环境温度Temperature : -40°C to +85°C  
 欧洲标准Europro Stander : 250V 16A 0.5~2.5mm<sup>2</sup>  
 美国标准USA Stander : 600V 20A 24-14AWG  
 中国标准China Stander : 250V 16A 0.5~2.5mm<sup>2</sup>

# IP68防水连接器系列 XYB15

IP68 Waterproof connector

NO.:2P 3P

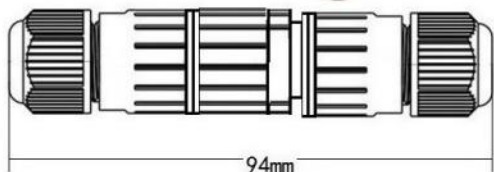

94mm

胶壳材质Housing : PA

五金材质Metal Material : 铜Brass

防水密封圈Waterproof O-Ring : 硅胶Silicon

环境温度Temperature : -40°C to +85°C

欧洲标准Europro Stander : 250V 16A 0.5~1.5mm<sup>2</sup>

美国标准USA Stander : 300V 10A 24-16AWG

中国标准China Stander : 450V 16A 0.5~1.5mm<sup>2</sup>

Φ8 OD: 6-8mm

# DIY



XYB15F + XYM15(M)

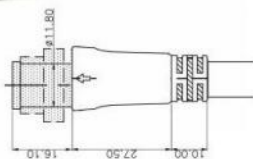
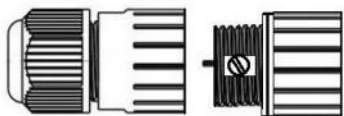

XYB15M + XYM15(F)

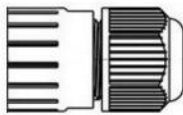
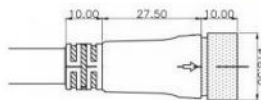

# IP68防水连接器系列 XYB15M+XYM15F

IP68 Waterproof connector

# DIY

NO.:2P 3P



XYM15F-2P 1 to 2

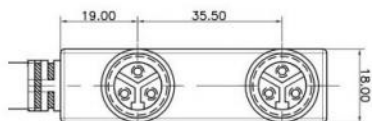
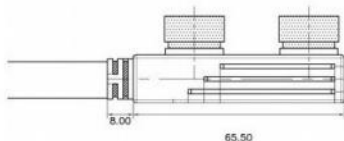

XYM15F-3P 1 to 2

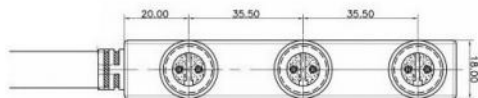

XYM15F-2P 1 to 3

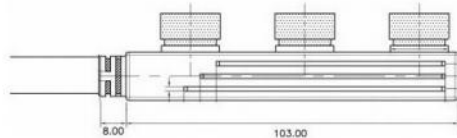

XYM15F-3P 1 to 3

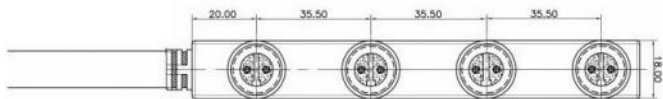

XYM15F-2P 1 to 4

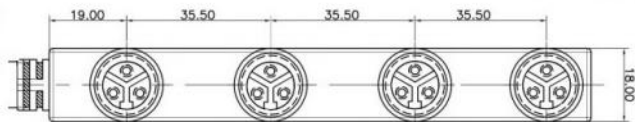
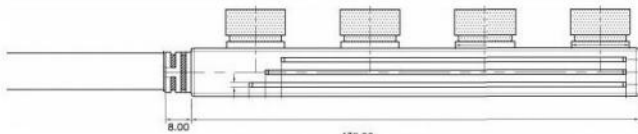

XYM15F-3P 1 to 4

# IP68防水连接器系列 IP68 Waterproof connector

## 产品尺寸 Product size XYM15F

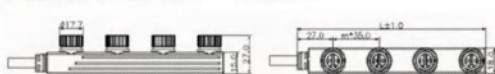

## 规格参数 Specification

芯数排列 Arrangement of cores	2 Pole	3 Pole	4 Pole
芯数 Number of poles	1*2	1*2 1*3	1*2 1*3 1*4 1*5 1*6 1*7
接触件直径×数量 Contact diameter×	2Xφ1.5	2Xφ1.5	2Xφ1.5+2Xφ1.0
额定电流 Rated current	10A	10A	10A+5A
额定电压 Rated Voltage	300V	300V	125V
耐电压 Withstand voltage	1500V	1500V	500V
绝缘电阻 Insulation resistance	> 5MΩ		
防护等级 IP rating	IP68		
使用寿命 Service life	> 500次		
线材规格 Wire specifications	0.5mm <sup>2</sup> -1.5mm <sup>2</sup> (20AWG-16AWG)		
线径范围 Size Range	φ4.0mm-φ9.0mm		
工作温度 operating temperature	-40°C~105°C		
连接方式 Connection method	压接SCREW		

## 材料 Material

外壳 绝缘部件 Housing Insulation	PA
铜针 Copper needle	铜BRASS
阻燃等级 Fire retardant rating	UL 94V0

## 产品尺寸 Product size XYM15

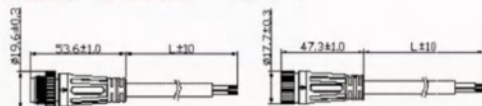

## 规格参数 Specification

芯数排列 Arrangement of cores	2 Pole			3 Pole			4 Pole		
	2 Pole	3 Pole	4 Pole	2 Pole	3 Pole	4 Pole	2 Pole	3 Pole	4 Pole
芯数 Number of poles	2	3	4	2	3	4	2	3	4
接触件直径×数量 Contact diameter×	2Xφ1.5	3Xφ1.5	2Xφ1.0 2Xφ1.5	2Xφ1.5	3Xφ1.5	2Xφ1.0 2Xφ1.5	2Xφ1.5	3Xφ1.5	2Xφ1.0 2Xφ1.5
额定电流 Rated current	10A	10A	10A+5A	10A	10A	10A+5A	10A	10A	10A+5A
额定电压 Rated Voltage	300V	300V	125V	300V	300V	125V	300V	300V	125V
耐电压 Withstand voltage	1500V			500V			1500V		
绝缘电阻 Insulation resistance	> 5MΩ								
防护等级 IP rating	IP68								
使用寿命 Service life	> 500次								
线材规格 Wire specifications	0.5mm <sup>2</sup> -1.5mm <sup>2</sup> (20AWG-16AWG)								
线径范围 Size Range	φ7.2mm-φ9.0mm								
工作温度 operating temperature	-40°C~105°C								
连接方式 Connection method	压接SCREW								

## 材料 Material

外壳 绝缘部件 Housing Insulation	PA
铜针 Copper needle	铜BRASS
阻燃等级 Fire retardant rating	UL 94V0

# IP68防水连接器系列 IP68 Waterproof connector

## 规格Model

XYM15Y-2P-R(1-2)  
 XYM15Y-2P-R(1-3)  
 XYM15Y-2P-R(1-4)  
 XYM15Y-2P-R(1-5)  
 XYM15Y-2P-R(1-6)  
 XYM15Y-2P-R(1-7)  
 XYM15Y-2P-R(1-8)

## 参数Specification

Y type one in two out 2X0.75mm<sup>2</sup> RUBBER L=25CM  
 Y type one in three out 2X0.75mm<sup>2</sup> RUBBER L=25CM  
 Y type one in four out 2X0.75mm<sup>2</sup> RUBBER L=25CM  
 Y type one in five out 2X0.75mm<sup>2</sup> RUBBER L=25CM  
 Y type one in six out 2X0.75mm<sup>2</sup> RUBBER L=25CM  
 Y type one in seven out 2X0.75mm<sup>2</sup> RUBBER L=25CM  
 Y type one in eight out 2X0.75mm<sup>2</sup> RUBBER L=25CM

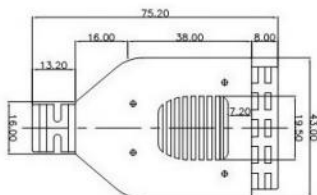
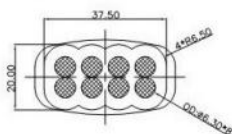

胶壳材质Housing : PA or PVC  
 五金材质Metal Material : 铜Brass  
 额定Rating : 10A 600V (实心solid)

## 规格Model

XYM15X  
 XYM15T

## 参数Specification

X type one in three out  
 T type one in two out

按照客户要求定制孔数  
 Produce the cable qty  
 by customer's requirement



## 规格Model

XYW18-2P-P(0.75)  
 XYW18-2P-R(0.75)  
 XYW18-3P-P(0.75)  
 XYW18-3P-R(0.75)  
 XYW18-4P-P(0.75+0.3)  
 XYW18-4P-R(0.75+0.3)  
 XYW18-5P-P(0.75+0.3)  
 XYW18-5P-R(0.75+0.3)

## 参数Specification

2X0.75mm<sup>2</sup> PVC Male and female 40CM  
 2X0.75mm<sup>2</sup> RUBBER Male and female 40CM  
 3X0.75mm<sup>2</sup> PVC Male and female 40CM  
 3X0.75mm<sup>2</sup> RUBBER Male and female 40CM  
 2X0.75+2X0.3mm<sup>2</sup> PVC Male and female 40CM  
 2X0.75+2X0.3mm<sup>2</sup> RUBBER Male and female 40CM  
 2X0.75+3X0.3mm<sup>2</sup> PVC Male and female 40CM  
 2X0.75+3X0.3mm<sup>2</sup> RUBBER Male and female 40CM



胶壳材质Housing : PA or PVC

五金材质Metal Material : 铜 Brass (空心Hollow and solid are available)

额定Rating : 8A 300V(空心Hollow) , 10A 600V (实心solid)

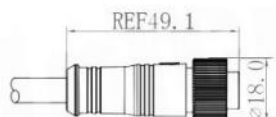
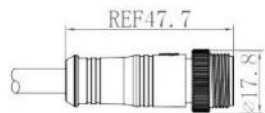

# IP68防水连接器系列 IP68 Waterproof connector

## 规格Model

XY15B-2P-R(0.75)  
 XY15B-3P-R(0.75)  
 XY15B-4P-R(0.75+0.3)  
 XY15B-5P-R(0.75+0.3)

## 参数Specification

2X0.75mm<sup>2</sup> RUBBER Male and female 40CM  
 3X0.75mm<sup>2</sup> RUBBER Male and female 40CM  
 2X0.75+2X0.3mm<sup>2</sup> RUBBER Male and female 40CM  
 2X0.75+3X0.3mm<sup>2</sup> RUBBER Male and female 40CM

## 图片Product



胶壳材质Housing : PA or PVC

五金材质Metal Material : 铜Brass (空心与实心可供选择Hollow and solid are available)

额定Rating : 8A 300V(空心Hollow) , 10A 600V(实心solid)

## 规格Model

## 参数Specification

XYM19-2P-R(0.5) 2X0.5mm<sup>2</sup> RUBBER Male and female 20cm  
 XYM19-2P-R(0.75) 2X0.75mm<sup>2</sup> RUBBER Male and female 20cm  
 XYM19-2P-R(1.0) 2X1.0mm<sup>2</sup> RUBBER Male and female 20cm  
 XYM19-3P-R(0.5) 3X0.5mm<sup>2</sup> RUBBER Male and female 20cm  
 XYM19-3P-R(0.75) 3X0.75mm<sup>2</sup> RUBBER Male and female 20cm

## 图片Product



胶壳材质Housing : PVC

五金材质Metal Material : 铜Brass

额定Rating : 8A 300V(空心Hollow)



## 规格Model

## 参数Specification

XYM19Y-2P-R(1-2) Y type one in out 2X0.75mm<sup>2</sup> RUBBER L=20CM  
 XYM19-2P-R(1-3) Y type one in out 2X0.75mm<sup>2</sup> RUBBER L=20CM  
 XYM19-2P-R(1-4) Y type one in out 2X0.75mm<sup>2</sup> RUBBER L=20CM  
 XYM19-2P-R(1-5) Y type one in out 2X0.75mm<sup>2</sup> RUBBER L=20CM  
 XYM19-2P-R(1-6) Y type one in out 2X0.75mm<sup>2</sup> RUBBER L=20CM  
 XYM19-2P-R(1-7) Y type one in out 2X0.75mm<sup>2</sup> RUBBER L=20CM  
 XYM19-2P-R(1-8) Y type one in out 2X0.75mm<sup>2</sup> RUBBER L=20CM

## 图片Product



胶壳材质Housing : PVC

五金材质Metal Material : 铜Brass

额定Rating : 8A 300V(空心Hollow)

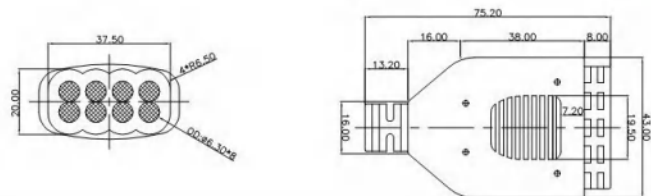

# IP68防水连接器系列 IP68 Waterproof connector

## 规格Model

XYW15-2P-P(0.75)  
 XYW15-2P-R(0.75)  
 XYW15-3P-P(0.75)  
 XYW15-3P-R(0.75)  
 XYW15-4P-P(0.75+0.3)  
 XYW15-4P-R(0.75+0.3)  
 XYW15-5P-P(0.75+0.3)  
 XYW15-5P-R(0.75+0.3)

## 参数Specification

2X0.75mm<sup>2</sup> PVC Male and female 40CM  
 2X0.75mm<sup>2</sup> RUBBER Male and female 40CM  
 3X0.75mm<sup>2</sup> PVC Male and female 40CM  
 3X0.75mm<sup>2</sup> RUBBER Male and female 40CM  
 2X0.75+2X0.3mm<sup>2</sup> PVC Male and female 40CM  
 2X0.75+2X0.3mm<sup>2</sup> RUBBER Male and female 40CM  
 2X0.75+3X0.3mm<sup>2</sup> PVC Male and female 40CM  
 2X0.75+3X0.3mm<sup>2</sup> RUBBER Male and female 40CM

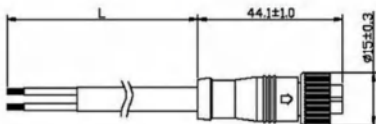
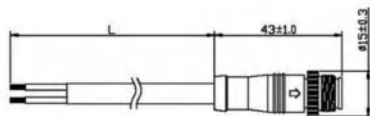

胶壳材质Housing : PA or PVC

五金材质Metal Material : 铜Brass (空心与实心可供选择Hollow and solid are available)

额定Rating : 8A 300V(空心Hollow) , 10A 600V (实心solid)

## 规格Model

XYM12(BW)-2P-R(0.75)  
 XYM12(BW)-3P-R(0.75)  
 XYM12(BW)-4P-R(0.75+0.3)  
 XYM12(BW)-5P-R(0.75+0.3)

## 参数Specification

2X0.75mm<sup>2</sup> RUBBER Male and female 40CM  
 3X0.75mm<sup>2</sup> RUBBER Male and female 40CM  
 2X0.75+2X0.3mm<sup>2</sup> RUBBER Male and female 40CM  
 2X0.75+3X0.3mm<sup>2</sup> RUBBER Male and female 40CM



胶壳材质Housing : PVC

五金材质Metal Material : 铜Brass

额定Rating : 8A 300V(空心Hollow)

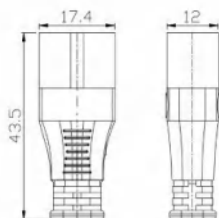

## 规格Model

XYBB12-2P-R(0.75)  
 XYBB12-3P-R(0.5)  
 XYBB15-2P-R(0.5)  
 XYBB15-3P-R(0.5)  
 XYBB18-3P-R(1.5)  
 XYBB18-4P-R(0.75)  
 XYBB18-4P-R(1.0)  
 XYBB18-4P-R(1.5)

## 参数Specification

2X0.75mm<sup>2</sup> RUBBER Male and female 40CM  
 3X0.5mm<sup>2</sup> RUBBER Male and female 40CM  
 2X0.75mm<sup>2</sup> RUBBER Male and female 40CM  
 3X0.5mm<sup>2</sup> RUBBER Male and female 40CM  
 3X1.5mm<sup>2</sup> RUBBER Male and female 40CM  
 4X0.75mm<sup>2</sup> RUBBER Male and female 40CM  
 4X1.0mm<sup>2</sup> RUBBER Male and female 40CM  
 4X0.5mm<sup>2</sup> RUBBER Male and female 40CM

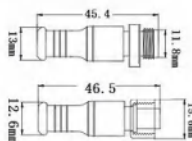

胶壳材质Housing : PA or PVC

五金材质Metal Material : 铜Brass (空心与实心可供选择Hollow and solid are available)

额定Rating : 8A 300V(空心Hollow) , 10A 600V (实心solid)

## 规格Model

XYM15F(B)-2P-R(1-2)  
 XYM15F(B)-2P-R(1-3)  
 XYM15F(B)-2P-R(1-4)  
 XYM15F(B)-2P-R(1-5)

## 参数Specification

F type one in two out ,M18 input 2x1.0mm<sup>2</sup> RUBBER  
 L=25CM,stripped 3CM tinned 3mm,With male connector  
 2pcs 2x0.75mm<sup>2</sup> RUBBER L=20CM  
 F type one in three out ,M18 input 2x1.0mm<sup>2</sup> RUBBER  
 L=25CM,stripped 3CM tinned 3mm,With male connector  
 2pcs 2x0.75mm<sup>2</sup> RUBBER L=20CM  
 F type one in four out ,M18 input 2x1.0mm<sup>2</sup> RUBBER  
 L=25CM,stripped 3CM tinned 3mm,With male connector  
 2pcs 2x0.75mm<sup>2</sup> RUBBER L=20CM  
 F type one in five out ,M18 input 2x1.0mm<sup>2</sup> RUBBER  
 L=25CM,stripped 3CM tinned 3mm,With male connector  
 2pcs 2x0.75mm<sup>2</sup> RUBBER L=20CM



胶壳材质Housing : PA or PVC

五金材质Metal Material : 铜Brass

(空心与实心可供选择Hollow and solid are available)

额定Rating : 8A 300V(空心Hollow) , 10A 600V (实心solid)

胶壳材质Housing : PA

防水等级IP:IP68



按客户要求定制线缆

Customize wiring to customer requirements

T1

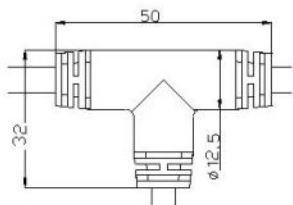

适用线材wire :

OD3.8-6.5mm

T2

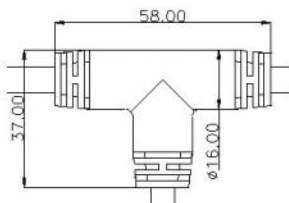

适用线材wire :

OD5.2-7.8mm

T3

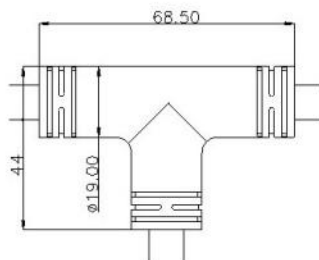

适用线材wire :

OD 5.2-10.2mm

# 阻水器 H<sub>2</sub>O stop

胶壳材质Housing : PA

防水等级IP:IP68

适用线材wire :

2X0.5mm<sup>2</sup>,2X0.75mm<sup>2</sup>,2X1.0mm<sup>2</sup>,2x1.5mm<sup>2</sup>

3X0.5mm<sup>2</sup>,3X0.75mm<sup>2</sup>,3X1.0mm<sup>2</sup>,3x1.5mm<sup>2</sup>

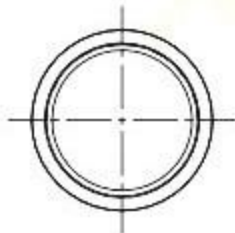
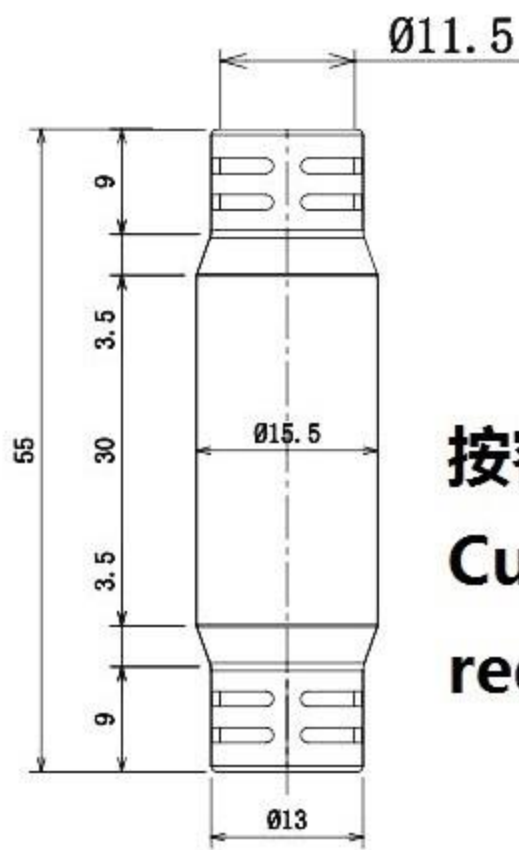
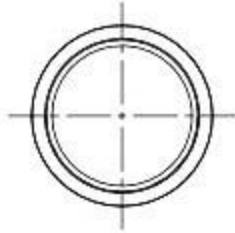

按客户要求定制线缆

Customize wiring to customer requirements



## MC4光伏连接器



材质Material-ROHS环保材料 PVC、橡胶Silicone、硅胶Rubber  
 Environmental protection material PPO  
 电缆类型Cable type 铜镀镍Nickle-plated brass  
 壳体材质Housing material 硅橡胶Silicon  
 压接式接线柱Crimping terminals -40~+105°C  
 防水密封圈Waterproof O-Ring  
 温度范围Temperature range  
 接线线径Clamps connecting capacity: 2.5/4.0/6.0mm2  
 工作电压Voltage: 1000V  
 工作安培current: 30A  
 防护等级Protection degree: IP67

## MC4(YS1-2)



2合1

## MC4(W1-3)



3合1



4合1

MC4(Y1-2)  
 MC4(Y1-3)  
 MC4(Y1-4)  
 MC4(Y1-5)  
 MC4(Y1-6)

## MC4(1-2)



2合1

## MC4(1-3)



3合1

## MC4(1-4)



4合1

## MC4(1-5)



5合1

## MC4(1-6)



6合1

# IP68防水连接器系列 IP68 Waterproof connector

XY20(RJ)-W01



XY22(RJ)-W01



XY22(RJ)-B01

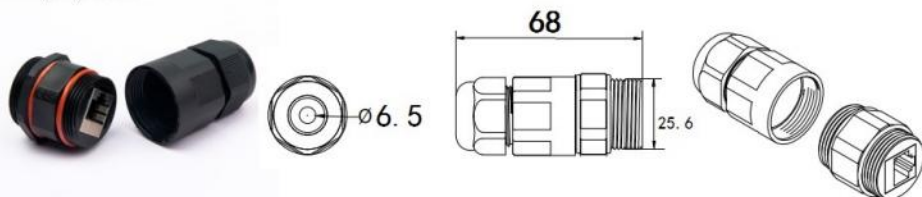

胶壳材质Housing material  
 防水胶圈材质Waterproof O-ring  
 端子Conductor  
 电缆固定头Cable  
 阻燃等级Fire rating  
 工作温度范围Operating temperature range  
 防水等级Waterproof rate

PA66  
 硅胶silicon  
 Cat6 (8P8C) : 1000BASE-T  
 M22X1.5  
 94V2  
 -40~+85°C  
 IP68

适用单水晶头网线



# IP68防水连接器系列 IP68 Waterproof connector

## XY22 (RJ) -M25-W01

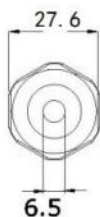
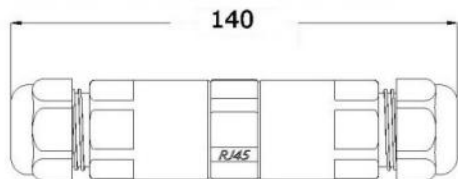
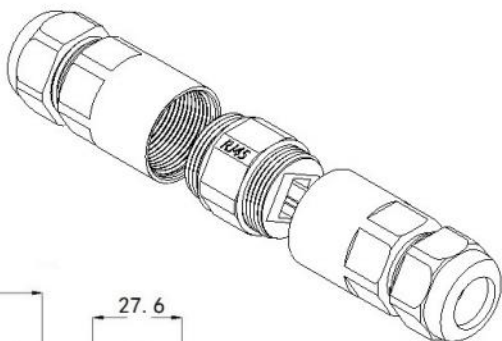

## XY22 (RJ) -M25-B01

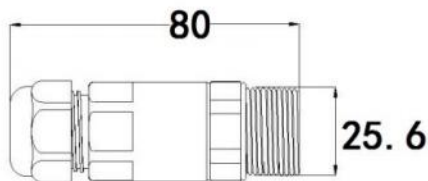
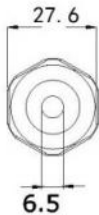

适用单水晶头网线

适用17.5mm以下护套水晶头网线



胶壳材质Housing material  
防水胶圈材质Waterproof O-ring  
端子Conductor  
电缆固定头Cable  
阻燃等级Fire rating  
工作温度范围Operating temperature range  
防水等级Waterproof rate

PA66  
硅胶silicon  
Cat6 (8P8C) : 1000BASE-T  
M25X1.5  
94V2  
-40~+85°C  
IP68



# IP68防水连接器系列 IP68 Waterproof connector

## XY11(Solder M14)-W01

1.线对线Wire to wire

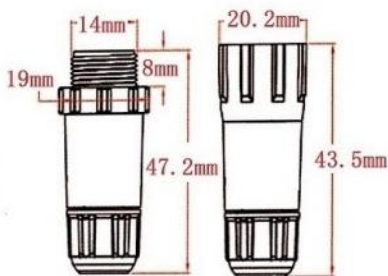

Φ7 OD: 6.5-7mm

NO.P	2	3	4	5	6	7	8
电流(A)	15A	15A	10A	10A	5A	5A	5A
电压(V)	250	250	250	250	125	125	125

材质Material-ROHS环保材料

Environmental protection material

电缆类型Cable type

壳体材质Housing material

焊接接线柱Crimping terminals

防水密封圈Waterproof O-Ring

温度范围Temperature range

PVC、橡胶Silicone、硅胶Rubber

阻燃\抗UV尼龙PA66

Flame retardant\Anti nylon PA66

铜镀金Gold-plated brass

硅橡胶Silicon

-40~+85°C

## XY12(Solder M16)-W01

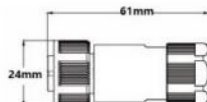
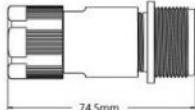

## XY12(Solder M16)-B02

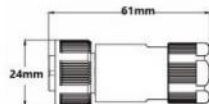
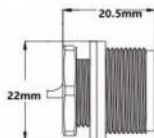

NO.P	2	3	4	5	6	7	8
电流(A)	15A	15A	10A	10A	5A	5A	5A
电压(V)	250	250	250	250	125	125	125

Φ8 OD: 6-8mm

Φ9 OD: 7-9mm

Φ11 OD: 9-11mm

材质Material-ROHS环保材料

Environmental protection material

电缆类型Cable type

壳体材质Housing material

PVC、橡胶Silicone、硅胶Rubber

阻燃\抗UV尼龙PA66

Flame retardant\Anti nylon PA66

焊接接线柱Crimping terminals

防水密封圈Waterproof O-Ring

温度范围Temperature range

铜镀金Gold-plated brass

硅橡胶Silicon

-40~+85°C

# IP68防水连接器系列 IP68 Waterproof connector

## XY13(Solder PG7)-W01

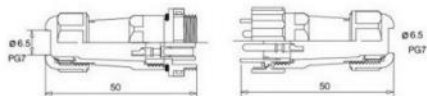

## XY13(Solder PG7)-B01

$\Phi 6.5$  OD: 3-6.5mm

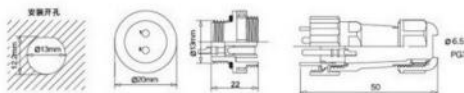

NO.P	2	3	4	5	6	7	9
电流(A)	10A	5A	5A	5A	5A	5A	5A
电压 (V)	250	250	250	250	125	125	125

材质Material-ROHS环保材料  
Environmental protection material  
电缆类型Cable type  
壳体材质Housing material

PVC、橡胶Silicone、硅胶Rubber  
阻燃抗UV尼龙PA66  
Flame retardant/Anti nylon PA66  
铜镀金Gold-plated brass  
硅橡胶Silicon  
-40~+85°C

焊接接线柱Crimping terminals  
防水密封圈Waterproof O-Ring  
温度范围Temperature range



## XY14(Solder PG9)-W01

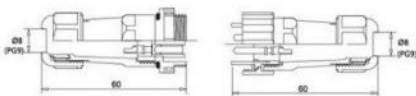

## XY14(Solder PG9)-B01

$\Phi 8$  OD: 4-8mm



NO.P	2	3	4	5	7	9
电流(A)	10A	10A	5A	5A	5A	5A
电压 (V)	250	250	250	250	250	250

材质Material-ROHS环保材料  
Environmental protection material  
电缆类型Cable type  
壳体材质Housing material

PVC、橡胶Silicone、硅胶Rubber  
阻燃抗UV尼龙PA66  
Flame retardant/Anti nylon PA66  
铜镀金Gold-plated brass  
硅橡胶Silicon  
-40~+85°C

焊接接线柱Crimping terminals  
防水密封圈Waterproof O-Ring  
温度范围Temperature range



# IP68防水连接器系列 IP68 Waterproof connector

## XY16(Solder PG13.5)-W01

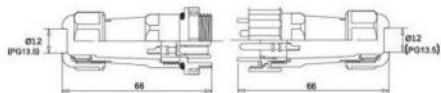

## XY16(Solder PG13.5)-B01

Ø12 OD:9-12mm

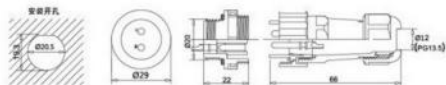

N.O.P	2	3	4	5	7	9	12
电流(A)	25A	25A	25A	10A	10A	5A	5A
电压(V)	250	250	250	250	250	250	250

材质Material-ROHS环保材料  
Environmental protection material

电缆类型Cable type PVC、橡胶Silicone、硅胶Rubber  
壳体材质Housing material 阻燃\抗UV\尼龙PA66  
Flame retardant\Anti nylon PA66  
焊接接线柱Crimping terminals 铜镀金Gold-plated brass  
防水密封圈Waterproof O-Ring 硅胶Silicon  
温度范围Temperature range -40~+85°C

## XY16 W01



## XY16B B01



# IP68防水连接器系列 IP68 Waterproof connector

## XYB16B B02

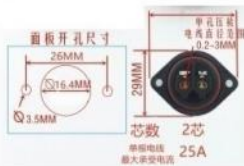

## XYB20 W01



## XYB20B B01



# IP68防水连接器系列 IP68 Waterproof connector

## XYB20B B02

### 直式插头+法兰式2孔插座



芯数	2芯	3芯	4芯	5芯	6芯	7芯
螺丝压接						
压接电线 直径范围	0.5-4mm <sup>2</sup>	0.5-4mm <sup>2</sup>	0.5-4mm <sup>2</sup>	0.5-2.5mm <sup>2</sup>	0.5-1.5mm <sup>2</sup>	0.5-1.5mm <sup>2</sup>
额定电流 最大承载电流	25A	25A	25A	10A	5A	5A

### 面板开孔尺寸



## XYB20B B03



芯数	2芯	3芯	4芯	5芯	6芯	7芯
螺丝压接						
压接电线 直径范围	0.5-4mm <sup>2</sup>	0.5-4mm <sup>2</sup>	0.5-4mm <sup>2</sup>	0.5-2.5mm <sup>2</sup>	0.5-2.5mm <sup>2</sup>	0.5-2.5mm <sup>2</sup>
额定电流 最大承载范围	25A	25A	25A	10A	5A	5A

### 面板开孔尺寸

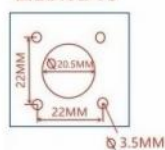

# IP68防水连接器系列 IP68 Waterproof connector M12X1.5-L

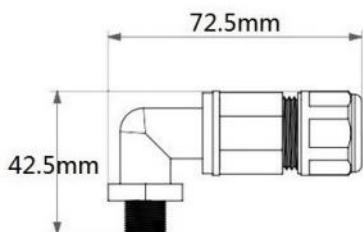
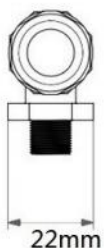

No.:2P 3P

胶壳材质Housing : PA

五金材质Metal Material : 铜Brass

防水密封圈Waterproof O-Ring : 硅胶Silicon

环境温度Temperature : -40°C to +85°C

欧洲标准Europe Stander : 250V 10A 0.5~1.5mm<sup>2</sup>

美国标准USA Stander : 300V 10A 24-16AWG

中国标准China Stander : 450V 10A 0.5~1.5mm<sup>2</sup>



φ 8 OD : 6-8mm

φ 9 OD : 7-9mm

φ 12 OD : 9-12mm



# IP68防水连接器系列 IP68 Waterproof connector

**XYM15 J**  
**NO.:2P**



胶壳材质Housing : PA  
五金材质Metal Material : 铜Brass  
防水密封圈Waterproof O-Ring : 硅胶Silicon  
环境温度Temperature : -40°C to +85°C  
欧洲标准Europe Stander : 250V 10A 0.5~1.5mm<sup>2</sup>  
美国标准USA Stander : 300V 10A 24-16AWG  
中国标准China Stander : 450V 10A 0.5~1.5mm<sup>2</sup>



剥线长度  
stripping length

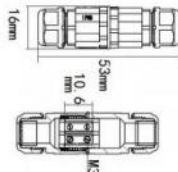
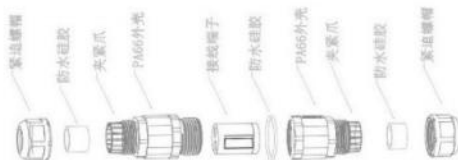

**XY16-W01 NO.:2P 3P**

线对线 Wire to wire

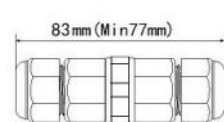

**XY16-W02 NO. :4P 5P**

线对线 Wire to wire

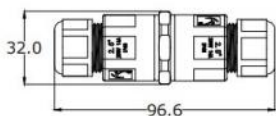

**XY16-B02 NO.:2P 3P**

线对板 Wire to board (PG13.5)

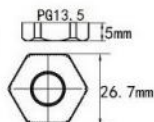
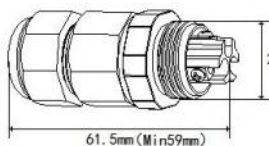

**XY16-B02 NO. :4P 5P**

线对板 Wire to board

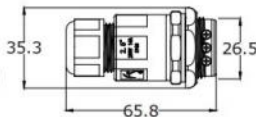

胶壳材质Housing : PA

五金材质Metal Material : 铜Brass

防水密封圈Waterproof O-Ring : 硅胶Silicon

环境温度Temperature : -40°C to +85°C

欧洲标准Europe Stander : 250V 16A 0.5~1.5/2.5mm<sup>2</sup>

美国标准USA Stander : 300V 18A 24-14AWG

中国标准China Stander : 450V 24A 0.5~2.5mm<sup>2</sup>

# IP68防水连接器系列 IP68 Waterproof connector XY12

线对线 WIRE TO WIRE NO.:2P 3P  $\phi 8$  OD:6-8mm



XY12-W01



XY12-W02

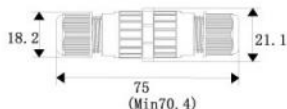
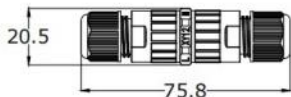

XY12-W04



XY12-W03

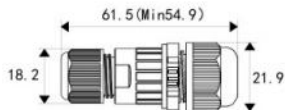

胶壳材质 Housing : PA

五金材质 Metal Material : 铜 Brass

防水密封圈 Waterproof O-Ring : 硅胶 Silicon

环境温度 Temperature : -40°C to +85°C

欧洲标准 Europe Stander : 250V 13A 0.5~1.5mm<sup>2</sup>

美国标准 USA Stander : 300V 13A 24-16AWG

中国标准 China Stander : 450V 10A 0.5~1.5mm<sup>2</sup>

线对板 WIRE TO BOARD NO.:2P 3P

$\phi 8$  OD:6-8mm



XY12-BM16



XY12-BPG7



XY12-BM12



XY12-BPG9

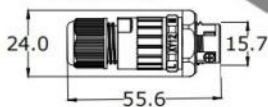

# IP68防水连接器系列 IP68 Waterproof connector XY12F

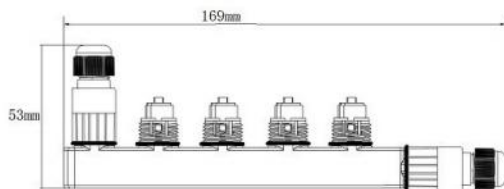
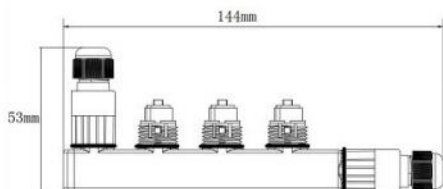
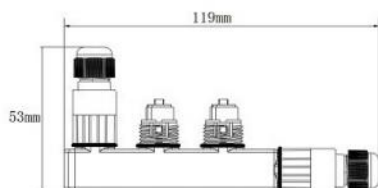
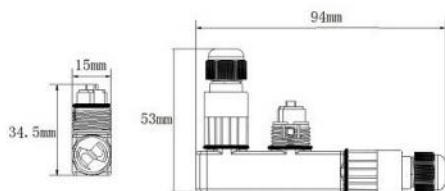

串联 SERIAL

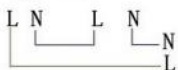

并联 PARALLEL

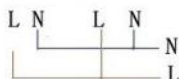

NO.P	XY12F(2PX2)	XY12F(2PX3)	XY12F(2PX4)	XY12F(2PX5)
	XY12F(3PX2)	XY12F(3PX3)	XY12F(3PX4)	XY12F(3PX5)

$\phi 8$  OD: 6-8mm

胶壳材质Housing : PA

五金材质Metal Material : 铜Brass

防水密封圈Waterproof O-Ring : 硅胶Silicon

环境温度Temperature : -40°C to +85°C

欧洲标准Eropre Stander : 250V 13A 0.5~1.5mm<sup>2</sup>

美国标准USA Stander : 300V 10A 24-16AWG

中国标准China Stander : 450V 10A 0.5~1.5mm<sup>2</sup>

# IP68防水连接器系列 IP68 Waterproof connector

XTT21 (Small, 1.5mm<sup>2</sup>) NO: 2P

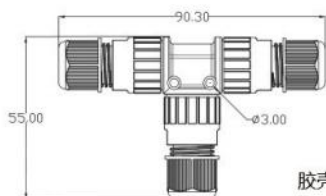

Φ8 OD: 6-8mm

胶壳材质Housing : PA

五金材质Metal Material : 铜Brass

防水密封圈Waterproof O-Ring : 硅胶Silicon

环境温度Temperature : -40°C to +85°C

欧洲标准Eropre Stander : 250V 16A 0.5~1.5mm<sup>2</sup>

美国标准USA Stander : 300V 10A 24-16AWG

中国标准China Stander : 450V 16A 0.5~1.5mm<sup>2</sup>

XYT21-W01 (1.5mm<sup>2</sup>) NO: 2P/3P/4P

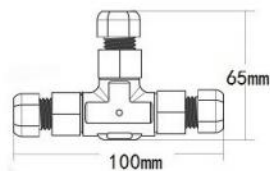

Φ8 OD: 6-8mm

XYT21-W02 (1.5mm<sup>2</sup>)

NO: 2P/3P/4P

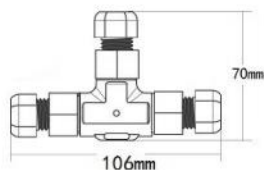

Φ8 OD: 6-8mm

Φ9 OD: 7-9mm

Φ12 OD: 9-12mm

XYT21-W03 (2.5mm<sup>2</sup>) NO: 2P/3P

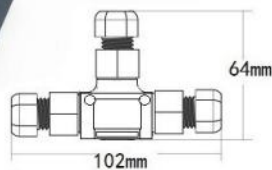

Φ8 OD: 6-8mm

Φ9 OD: 7-9mm

Φ12 OD: 9-12mm

# IP68防水连接器系列 IP68 Waterproof connector

## XYX21 (SMALL)

NO.:2P

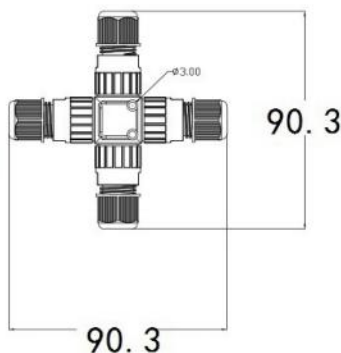
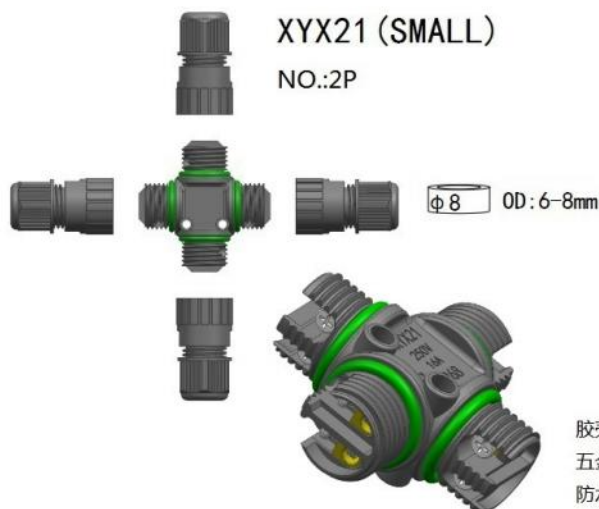

胶壳材质Housing : PA

五金材质Metal Material : 铜Brass

防水密封圈Waterproof O-Ring : 硅胶Silicon

环境温度Temperature : -40°C to +85°C

欧洲标准Europre Stander : 250V 16A 0.5~1.5mm<sup>2</sup>

美国标准USA Stander : 300V 10A 24-16AWG

中国标准China Stander : 450V 16A 0.5~1.5mm<sup>2</sup>

XYX21-W01



NO.:2P 3P 4P

φ 8 OD: 6-8mm

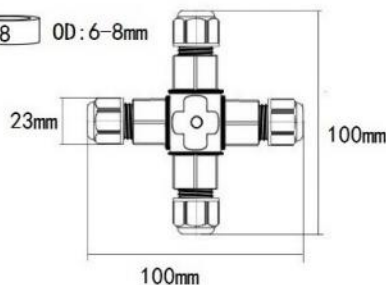

XYX21-W02

NO.:2P 3P 4P

φ 8 OD: 6-8mm

φ 9 OD: 7-9mm

φ 12 OD: 9-12mm

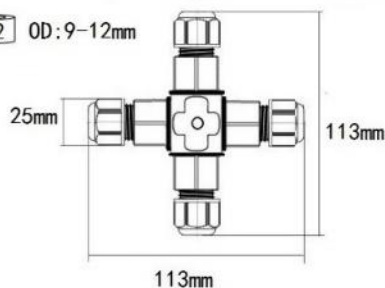

XYT25

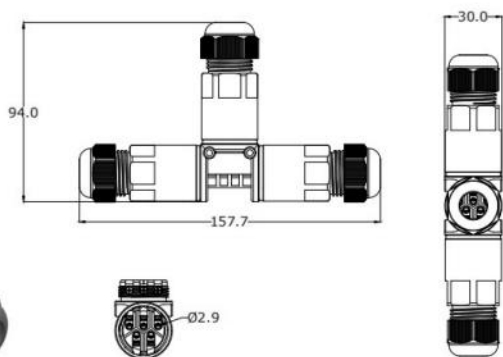

XYX25

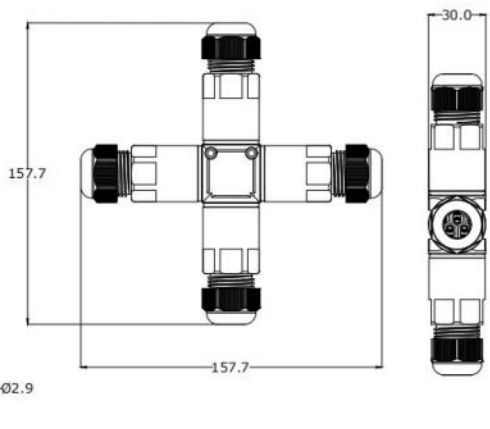

胶壳材质Housing : PA

五金材质Metal Material : 铜Brass

防水密封圈Waterproof O-Ring : 硅胶Silicon

环境温度Temperature : -40°C to +85°C

欧洲标准Erope Stander : 250V 16A 0.5~2.5mm<sup>2</sup>

美国标准USA Stander : 300V 18A 24-14AWG

中国标准China Stander : 450V 16A 0.5~2.5mm<sup>2</sup>

# IP68防水连接器系列 IP68 Waterproof connector

XYS20-W01 NO.:2P 3P 4P 5P



82.5mm



XYS20-B01 NO.:2P 3P 4P 5P  
线对板焊到板 (M16)



76.5mm



M16

XY20(Y)-W01 NO.:2P 3P 4P 5P

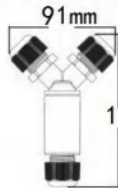

91mm

104mm

Φ9 OD: 7-9mm

Φ12 OD: 9-12mm

XYS20-W02

NO.:2P 3P 4P 5P



Breathing apparatus

82.5mm



胶壳材质Housing : PA

五金材质Metal Material : 铜Brass

防水密封圈Waterproof O-Ring : 硅胶Silicon

环境温度Temperature : -40°C to +85°C

欧洲标准Eupro Stander : 250V 16A 0.5~1.5mm<sup>2</sup>

美国标准USA Stander : 300V 10A 24-16AWG

中国标准China Stander : 450V 16A 0.5~1.5mm<sup>2</sup>

XY20-W01

NO.:2P 3P

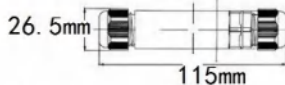

26.5mm

115mm

Φ9 OD: 7-9mm

Φ12 OD: 9-12mm

XY20-W02

NO.:2P 3P



Breathing apparatus



26.5mm

115mm

胶壳材质Housing : PA

五金材质Metal Material : 铜Brass

防水密封圈Waterproof O-Ring : 硅胶Silicon

环境温度Temperature : -40°C to +85°C

XY20(Y)-W01 NO.:2P 3P

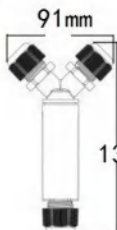

91mm

132mm

欧洲标准Eupro Stander : 250V 16A 0.5~1.5/2.5mm<sup>2</sup>

美国标准USA Stander : 300V 20A 24-14AWG

中国标准China Stander : 450V 24A 0.5~2.5mm<sup>2</sup>

XY25-W01 (M20-M25)

NO.:2P 3P 4P 5P



Φ9 OD: 7-9mm

Φ12 OD: 9-12mm

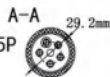

5P

A-A

29.2mm

五金材质Metal Material : 铜Brass

防水密封圈Waterproof O-Ring : 硅胶Silicon

环境温度Temperature : -40°C to +85°C

欧洲标准Eupro Stander : 250V 16A 0.5~1.5/2.5mm<sup>2</sup>

美国标准USA Stander : 300V 20A 24-14AWG

中国标准China Stander : 450V 24A 0.5~2.5mm<sup>2</sup>

XY25-W02 (M25-M25)

NO.:2P 3P 4P 5P

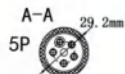

A-A

5P

29.2mm

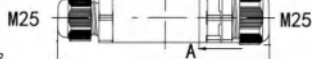

M25

M25

124mm

119mm

# IP68防水连接器系列 IP68 Waterproof connector

XY25(T)-W01 (M20-M20)



NO.:2P 3P 4P 5P

φ9 OD: 7-9mm

φ12 OD: 9-12mm

φ14 OD: 12-14mm

XY25(T)-W02 (M20-M25)



NO.:2P 3P 4P 5P

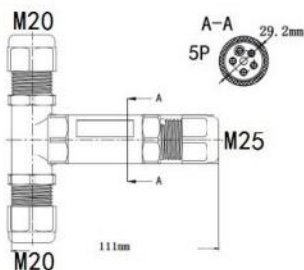
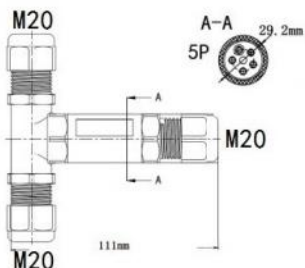

XY25(Y)-W01 (M20-M25)

NO.:2P 3P 4P 5P



φ9 OD: 7-9mm

φ12 OD: 9-12mm

φ14 OD: 12-14mm

XY25(Y)-W02 (M25-M25)

NO.:2P 3P 4P 5P

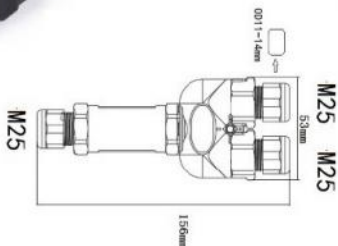
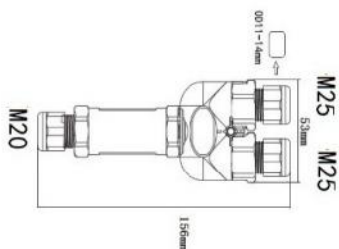

胶壳材质Housing: PA

五金材质Metal Material: 铜Brass

防水密封圈Waterproof O-Ring: 硅胶Silicon

环境温度Temperature: -40°C to +85°C

欧洲标准Erope Stander: 250V 16A 0.5~1.5/2.5mm<sup>2</sup>

美国标准USA Stander: 300V 20A 24-14AWG

中国标准China Stander: 450V 24A 0.5~2.5mm<sup>2</sup>

# IP68防水连接器系列 IP68 Waterproof connector

XYCA8-W01 NO.:2P 3P

线对线wire to wire/线对板wire to board M20X1.5

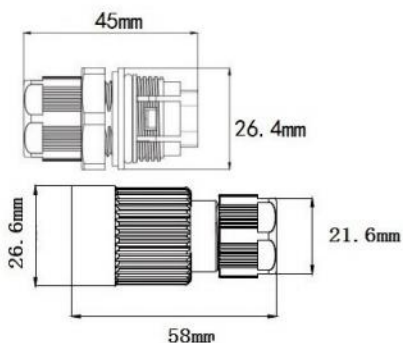

XYCA8-B01 NO.:2P 3P

线对板wire to board M16X1.5

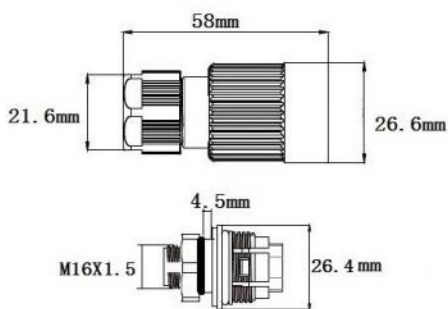

16A



25A

Φ8 OD: 6-8mm

Φ11 OD: 8-11mm

防尘帽 XY02 Cover



胶壳材质Housing : PA

五金材质Metal Material : 铜Brass

防水密封圈Waterproof O-Ring : 硅胶Silicon

环境温度Temperature : -40°C to +85°C

欧洲标准Eroproe Stander : 250V 16A/25A 0.5~2.5mm<sup>2</sup>

美国标准USA Stander : 300V 16A/25A 24-14AWG

中国标准China Stander : 450V 16A/25A 0.5~2.5mm<sup>2</sup>

## XYW26

NO.:5P



φ8 OD: 6-8mm

φ9 OD: 7-9mm

φ12 OD: 9-12mm

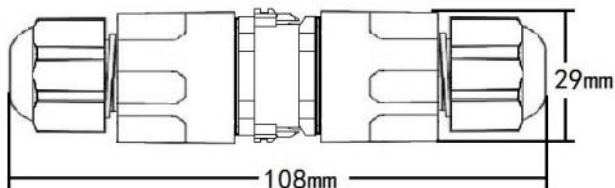
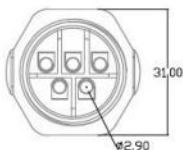

## XYW18

NO.:3P

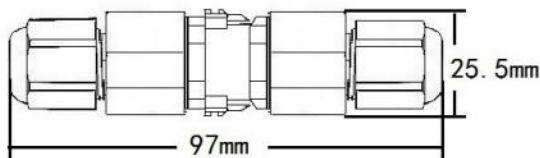

φ8 OD: 6-8mm

φ9 OD: 7-9mm

φ12 OD: 9-12mm

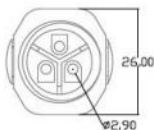

胶壳材质Housing : PA

五金材质Metal Material : 铜Brass

防水密封圈Waterproof O-Ring : 硅胶Silicon

环境温度Temperature : -40°C to +85°C

欧洲标准Erope Stander : 250V 16A 0.5~2.5mm<sup>2</sup>

美国标准USA Stander : 300V 18A 24-14AWG

中国标准China Stander : 450V 16A 0.5~2.5mm<sup>2</sup>

## XYW16

NO.:2P



φ8 OD: 6-8mm

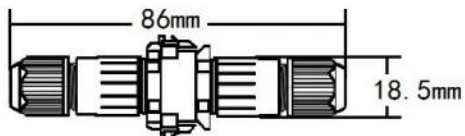
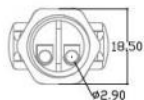

## M12X1.5(BAP)

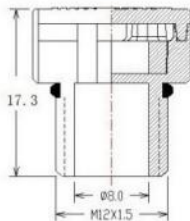

材质Material-ROHS环保材料  
 Environmental protection material  
 壳体材质Housing material PP+E-PTFE  
 防水密封圈Waterproof O-Ring 硅橡胶Silicon  
 温度范围Temperature range -40~+85°C  
 颜色color:白色white,黑色black, 透明transparent

## M10X1(BAP)

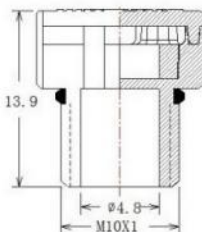

材质Material-ROHS环保材料  
 Environmental protection material  
 壳体材质Housing material PP+E-PTFE  
 防水密封圈Waterproof O-Ring 硅橡胶Silicon  
 温度范围Temperature range -40~+85°C  
 颜色color:白色white,黑色black, 透明transparent

## SK5(BAP)

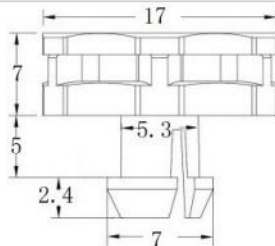

材质Material-ROHS环保材料  
 Environmental protection material  
 壳体材质Housing material PP+E-PTFE  
 防水密封圈Waterproof O-Ring 硅橡胶Silicon  
 温度范围Temperature range -40~+85°C  
 颜色color:白色white,黑色black, 透明transparent

# 呼吸器 Breathing apparatus

M05X0.8



M06X1.0

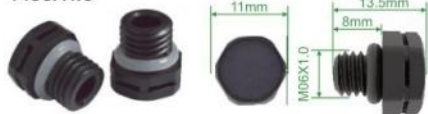

M08X1



M10X1.0



M10X1.5

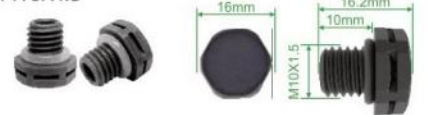

M12X1.0



M12X1.5



M14X1.5



M16X1.5



M24X1.5



K05 卡扣式



D06 透气塞



D13 透气塞



材质Material-ROHS环保材料  
Environmental protection material  
壳体材质Housing material PP+E-PTFE

防水密封胶Waterproof O-Ring 硅橡胶Silicon  
温度范围Temperature range -40~+85°C  
颜色color:白色white,黑色black,透明transparent

# 呼吸器 Breathing apparatus

M10X1.5

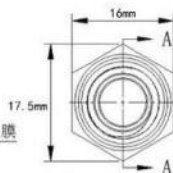
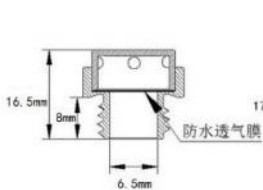

M12X1.5

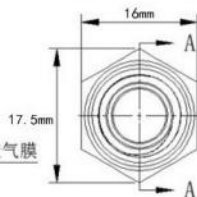
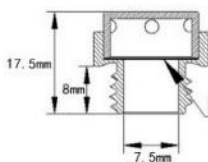
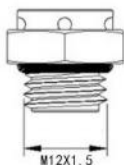

M14X1.5

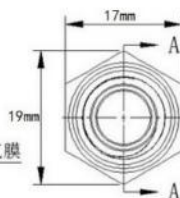
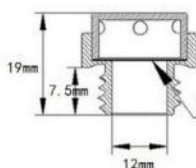
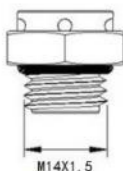

M16X1.5

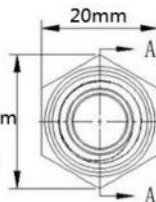
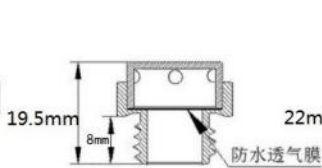
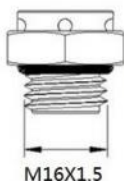

材质Material: 铜BRASS, E-PTFE

硅胶 Silicon

透气性: 1.2L/min/CM (压差70mbar)



# 塑料塞头 Plastic head



材质Material-ROHS环保材料  
Environmental protection material  
壳体材质 阻燃抗UV尼龙PA66  
Housing material  
防水密封圈 硅橡胶Silicon  
Waterproof O-Ring



螺纹规格	螺纹长度GL	总高度H	总长度D	螺纹长度AG
PG7	8.5	12.5	15	12.5
PG9	8.5	13	19	15.2
PG11	9	13	22	18.6
PG13.5	9	13	25	20.4
PG16	10.5	15	27	22.5
PG21	10.5	15.5	33	28.3
PG29	11	15	43	36
PG36	13.5	18	55	47
PG42	13.5	18.5	62	54
PG48	14.5	19.5	68	59.3
M12x1.5	8.5	12.5	15	12
M16x1.5	8.5	13	19	16
M18x1.5	9	13	22	18
M20x1.5	9	13	25	20
M22x1.5	10.5	15	27	22
M25x1.5	10.5	15.5	30	25
M27x1.5	10.5	15.5	33	27
M32x1.5	10.5	16	38	32
M40x1.5	11.5	16	46	40
M50x1.5	13.5	18	56	50
M63x1.5	14	19	68	63

## 电缆固定头 Cable gland



胶壳材质Housing material : PA

垫圈材质Waterproof O-ring : 硅胶silicon

适用电缆Waterproof rate : OD 3-7.5mm

适用机板孔口径Mounting Holes : 13.3~13.7mm

环境 温度temperature : -40°C to +85°C

防水等级Waterproof rate : IP68

型号Model : M12-6



型号Model : M12-3



投  
光  
灯  
专  
用



# 塑料电缆固定头

## 1. Plastic cable gland

## 2. Plastic cable gland with breathing



材质Material-ROHS环保材料

Environmental protection material

电缆类型Cable type

PVC、橡胶Silicone、硅胶Rubber

壳体材质Housing material

阻燃\抗UV尼龙PA66

Flame retardant\Anti nylon PA66

防水密封圈Waterproof O-Ring

硅胶Silicon

工作温度Working Temperature

静态 -40°C至100°C，瞬时耐至120°C

-40°C to 100°C in static state, instantaneous heat resistance up to 120°C

动态 -20°C至80°C，瞬时耐至100°C

-20°C to 80°C in dynamic state, instantaneous heat resistance up to 100°C



新品NEW

专利产品

Breathing apparatus

型号 Model	螺纹 Thred size	适用电缆 Cable range(mm)	螺纹外径 Thread O.D. L2(mm)	螺纹长度 Thread Length L1(mm)	扳手直径 Spanner size A&E(mm)
PG7	PG7	3-6.5	12.5	9	18/16
PG9	PG9	4-8	15.2	9	22/19
PG11	PG11	5-10	18.6	9	24/22
PG13.5	PG13.5	6-11	20.4	10	27/24
PG16	PG16	10-13	22.5	10	30/27
PG19	PG19	12-15	24	10	30/28
PG21	PG21	13-18	28.3	12	35/33
PG25	PG25	16-21	30	12	37/35
PG29	PG29	18-25	37	12	45/42
PG36	PG36	22-32	47	15	58/52
PG42	PG42	32-38	54	18	62/58
PG48	PG48	37-44	59.3	18	70/64
PG63	PG63	42-50	71	30	83/77
M8	M8X1.25	2.5-4.5	8	7.5	13/12
M10	M10X1.5	3-6	10	8	15/13
M12	M12X1.5	3-6.5	12	9	18/16
M14	M14X1.5	4-8	14	9	22/19
M16	M16X1.5	4-8	16	9	22/19
M18	M18X1.5	5-10	18	9	24/22
M20	M20X1.5	6-11	20	10	27/24
M22	M22X1.5	10-13	22	10	30/27
M24	M24X1.5	12-15	24	10	30/27
M25	M25X1.5	12-15	25	10	31/27
M27	M27X1.5	13-18	27	12	35/32
M28	M28X1.5	13-18	28	12	35/33
M30	M30X1.5	16-21	30	12	37/35
M32	M32X1.5	16-21	32	12	38/34
M36	M36X1.5	18-25	36	12	45/42
M40	M40X1.5	22-33	40	15	51/51
M46	M46X1.5	22-23	46	15	58/52
M48	M48X1.5	22-23	48	15	58/52
M50	M50X1.5	32-38	50	18	62/58
M58	M58X1.5	37-44	58	18	70/64
M63	M63X1.5	37-44	63	18.5	71/69
M70	M70X1.5	42-51	70	30	82/77

# 金属电缆固定头

- 1.Metal cable glang
- 2.Metal cable gland with berathing



材质Material-ROHS环保材料

Environmental protection material

电缆类型Cable type

PVC、橡胶Silicone、硅胶Rubber

壳体材质Housing material

铜 BRASS

防水密封圈Waterproof O-Ring

硅胶Silicon

工作温度working Temperature

静态 -40°C至100°C，瞬时耐热至120°C

-40°C to 100°C in static state, instantaneous heat resistance up to 120°C

动态 -20°C至80°C，瞬时耐热至100°C

-20°C to 80°C in dynamic state, instantaneous heat resistance up to 100°C



新品NEW  
专利产品  
Breathing apparatus



型号 Model	螺纹 Thred size	适用电缆 Cable range(mm)	螺纹外径 Thread O.D. L2(mm)	螺纹长度 Thread Length L1(mm)	扳手直径 Spanner size A&E(mm)
PG7	PG7	3-6.5	12.5	5	14
PG9	PG9	4-8	15.2	6	17
PG11	PG11	5-10	18.6	6	20
PG13.5	PG13.5	6-11	20.4	6.5	22
PG16	PG16	10-13	22.5	6.5	24
PG21	PG21	13-18	28.3	7	30
PG29	PG29	18-25	37	8	40
PG36	PG36	22-32	47	9	50
PG42	PG42	32-38	54	10	58
PG48	PG48	37-44	59.3	10	63
M8	M8X1.25	2.5-4.5	8	5	11
M10	M10X1.5	3-6	10	5	13
M12	M12X1.5	3-6.5	12	5	14
M14	M14X1.5	4-8	14	6	17
M16	M16X1.5	4-8	16	6	17
M18	M18X1.5	6-11	18	6	20
M20	M20X1.5	7-13	20	6	22
M22	M22X1.5	9-14	22	6	24
M24	M24X1.5	9-14	24	7	30
M25	M25X1.5	9-14	25	7	30
M27	M27X1.5	11-18	27	7	30
M30	M30X1.5	11-18	30	7	37
M32	M32X1.5	15-22	32	8	37
M33	M33X1.5	15-22	33	8	37
M36	M36X1.5	18-26	36	8	42
M40	M40X1.5	18-26	40	8	46
M42	M42X1.5	18-26	42	9	46
M48	M48X1.5	24-33	48	9	52
M50	M50X1.5	30-38	50	9	60
M54	M54X1.5	30-38	54	9	60
M60	M60X1.5	34-45	60	9	70
M63	M63X1.5	34-45	63	10	70
M64	M64X1.5	34-45	64	10	70

# 防水接线盒 Waterproof Box XYPG9IP65(B703)XXX-option

胶壳材质Housing:PP

导体材质Metal Part:铜Brass

防水圈材质Waterproof O-Ring:硅胶Silicon

温度范围Temperature range:-40°C~+85°C

颜色Color:黑色Black

额定 Rated: 0.5~2.5mm<sup>2</sup> 16A 450V IP65 OD4-8mm

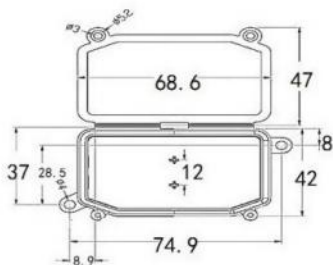

接线方式 Wiring Method	Screw Terminal Block	接线方式 Wiring Method	Quick Connector
	型号 NO. option  203	盒子尺寸 Size box mm  124x45x32	
	型号 NO. option  303	盒子尺寸 Size box mm  124x72x32	
	型号 NO. option  403	盒子尺寸 Size box mm  124x72x32	

# 防水接线盒 Waterproof Box XYPG9IP66(B704)XXX-option

胶壳材质Housing:PP

导体材质Metal Part:铜Brass

防水圈材质Waterproof O-Ring:硅胶Silicon

温度范围Temperature range:-40°C~+85°C

颜色Color:黑色Black

额定Rated: 0.5~2.5mm<sup>2</sup> 16A 450V IP66 OD4-8mm

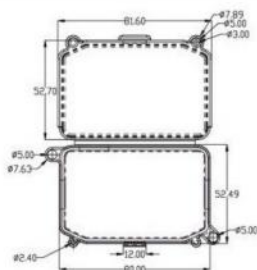

接线方式  
Wiring  
Method

Screw  
Terminal  
Block



型号  
NO.  
option

盒子尺寸  
Size box  
mm



型号  
NO.  
option

盒子尺寸  
Size box  
mm

204

137x56x31

304

137x82x31



型号  
NO.  
option

盒子尺寸  
Size box  
mm



型号  
NO.  
option

盒子尺寸  
Size box  
mm



型号  
NO.  
option

盒子尺寸  
Size box  
mm

404

137x82x31

504

137x108x31

604

137x108x31

接线方式  
Wiring  
Method

Quick  
Connector



型号  
NO.  
option

盒子尺寸  
Size box  
mm



型号  
NO.  
option

盒子尺寸  
Size box  
mm

214

137x56x31

314

137x82x31



型号  
NO.  
option

盒子尺寸  
Size box  
mm



型号  
NO.  
option

盒子尺寸  
Size box  
mm



型号  
NO.  
option

盒子尺寸  
Size box  
mm

414

137x82x31

514

137x108x31

614

137x108x31

# 防水接线盒 Waterproof Box XYPG9 IP68(B705)XXX-option

胶壳材质Housing:PA66

导体材质Metal Part:铜Brass

防水圈材质Waterproof O-Ring:硅胶Silicon



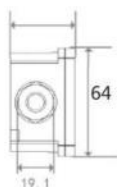
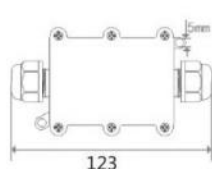
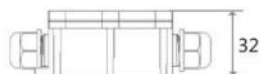

温度范围Temperature rangge:-40°C~+85°C

颜色Color:黑色Black



With Screw Terminal Block

With Quick Connector

NO.	型号 NO. option	盒子尺寸 Size box mm	接线范围 Cable Gland oDmm	接线方式 Wiring Method	经线 Wire Size mm <sup>2</sup>	电流 /电压 A/V	防水 等级 IP
	204	123x64x32	4-8	Screw Terminal Block	0.5-2.5	16A /450V	IP68
	214			Quick Connector			
	304	123x81x32		Screw Terminal Block			
	314			Quick Connector			
	404	123x86x32		Screw Terminal Block			
	414			Quick Connector			
	504	123x101x32		Screw Terminal Block			
	514			Quick Connector			
	604	123x101x32		Screw Terminal Block			
	614			Quick Connector			

## 防水接线盒 Waterproof Box XYPG9(ABS)XXX-option

胶壳材质Housing:ABS





导体材质Metal Part:铜Brass

防水圈材质Waterproof O-Ring:硅胶Silicon

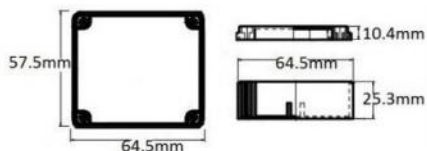
温度范围Temperature range:-40°C~+85°C

颜色Color:黑色Black



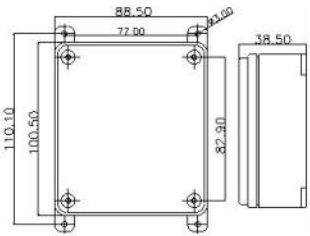

型号 NO. option	盒子尺寸 Size box mm	接线范围 Cable Gland oDmm	接线方式 Wiring Method	经线 Wire Size mm <sup>2</sup>	电流 /电压 A/V	防水 等级 IP
304	122.5x86.5x35.5	4-8	Screw Terminal Block 	0.5-2.5	24A /450V	IP65
314	122.5x86.5x35.5		Quick Connector 			
404	115.5x86.5x35.5		Screw Terminal Block 			
414	115.5x86.5x35.5		Quick Connector 			

# 防水接线盒 Waterproof Box XYPG9 IP67(B706)

型号 Model	盒子尺寸 Size box mm	材质 housing	防水等级 IP
<p>XYPG9 IP67(B706)</p> 		ABS	IP67

端子可选配件 Two alternative terminal inside(max.6 poles also ok)

NO.	型号 Model	接线方式 Wiring Method	经线 Wire Size mm <sup>2</sup>	电流/电压 A/V	材质 housing
	0	Screw Terminal Block	0.5-2.5	24A/450V	PA66
	1	Quick Connector	0.5-2.5	24A/450V	PA66

端子可选配件 Two alternative terminal inside(max.6 poles also ok)

NO.	型号 Model	接线范围 Cable Gland oDmm	材质 housing
	P1	4-8	PA66
	P2	6-12	PA66

# 防水接线盒 Waterproof Box XYPG9 IP67(B706)

例子  
Example

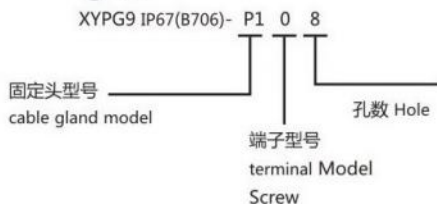
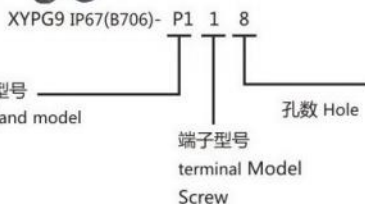
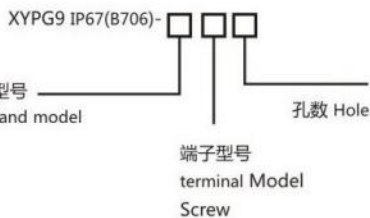

XYPG9 IP67(B706)-P104  
XYPG9 IP67(B706)-P114



XYPG9 IP67(B706)-P106  
XYPG9 IP67(B706)-P116



按照客户要求定制孔数及打孔位置  
Produce the cable qty and cable location by customer's requirement

XYPG9 IP67(B706)-P103  
XYPG9 IP67(B706)-P113



XYPG9 IP67(B706)-P104  
XYPG9 IP67(B706)-P114





XYPG9 IP67(B706)-P102  
XYPG9 IP67(B706)-P112

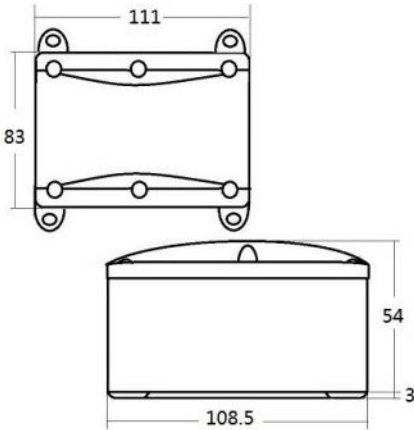

# 防水接线盒 Waterproof Box XYPG9 IP68(B707)

型号 Model	盒子尺寸 Size box mm	材质 housing	防水等级 IP
		ABS	IP68

可选配件 Two alternative terminal inside(max.6 poles also ok)

NO.	型号 Model	接线方式 Wiring Method	线径 Wire Size mm <sup>2</sup>	电流/电压 A/V	材质 housing
	0	Screw Terminal Block	0.5-2.5	24A/450V	PA66
	1	Quick Connector	0.5-2.5	24A/450V	PA66

可选配件 Two alternative terminal inside(max.6 poles also ok)

NO.	型号 Model	接线范围 Cable Gland oDmm	材质 housing
	P1	4-8	PA66
	P2	6-12	PA66

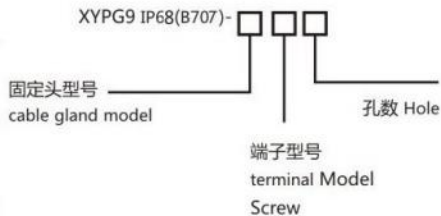

按照客户要求定制孔数及打孔位置  
Produce the cable qty and cable location by customer's requirement

# 防水接线盒 Waterproof Box XYM20-3

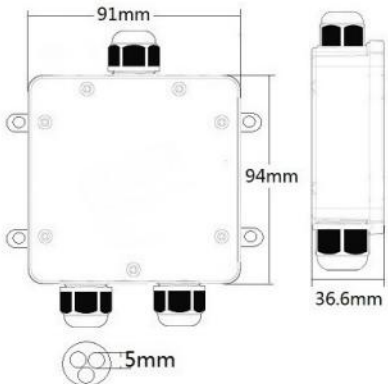
型号 Model	盒子尺寸 Size box mm	材质 housing	防水等级 IP
		ABS	IP68

可选配件 Two alternative terminal inside(max.6 poles also ok)

NO.	型号 Model	接线方式 Wiring Method	线径 Wire Size mm <sup>2</sup>	电流/电压 A/V	材质 housing
	0	Screw Terminal Block	0.5-2.5	24A/450V	PA66
	1	Quick Connector	0.5-2.5	24A/450V	PA66

可选配件 Two alternative terminal inside(max.6 poles also ok)

NO.	型号 Model	接线范围 Cable Gland oDmm	材质 housing
	P1	4-8	PA66
	P2	6-12	PA66

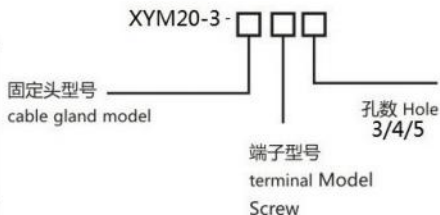

按照客户要求定制孔数及打孔位置  
Produce the cable qty and cable location by customer's requirement

## 防水接线盒 Waterproof Box XYM20(PC-4)XXX-option

胶壳材质Housing:PC

导体材质Metal Part:铜Brass

防水圈材质Waterproof O-Ring:硅胶Silicon

温度范围Temperature range:-40°C~+85°C

颜色Color:透明

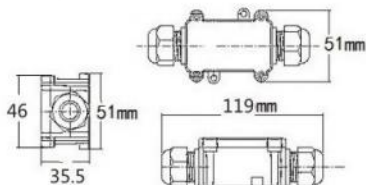

型号 NO. option	盒子尺寸 Size box mm	接线范围 Cable Gland oDmm	接线方式 Wiring Method	经线 Wire Size mm <sup>2</sup>	电流 /电压 A/V	防水 等级 IP
203	119x46x35.5	6-12	Screw Terminal Block	0.5-2.5	24A /450V	IP68
213	119x46x35.5		Quick Connector			
303	119x75x35.5		Screw Terminal Block			
313	119x75x35.5		Quick Connector			
403	119x104x35.5		Screw Terminal Block			
413	119x104x35.5		Quick Connector			

# 防水接线盒 Waterproof Box XYM20(PC-6)XXX-option

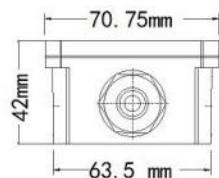
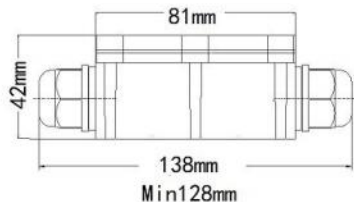

胶壳材质Housing:PC

导体材质Metal Part:铜Brass

防水圈材质Waterproof O-Ring:硅胶Silicon

温度范围Temperature range:-40°C~+85°C

颜色Color:透明

型号 NO. option	盒子尺寸 Size box mm	接线范围 Cable Gland oDmm	接线方式 Wiring Method	经线 Wire Size mm <sup>2</sup>	电流 /电压 A/V	防水 等级 IP
204	138x63.5x42	6-12	Screw Terminal Block	0.5-2.5	16A /450V	IP68
214	138x63.5x42		Quick Connector			
304	138x92.5x42		Screw Terminal Block			
314	138x92.5x42		Quick Connector			
404	138x121.4x42		Screw Terminal Block			
414	138x121.4x42		Quick Connector			
504	138x121.4x42		Screw Terminal Block			
514	138x121.4x42		Quick Connector			
604	138x121.4x42		Screw Terminal Block			
614	138x121.4x42		Quick Connector			

## 防水接线盒 Waterproof Box XYM20

胶壳材质Housing:PA66

导体材质Metal Part:铜Brass

防水圈材质Waterproof O-Ring:硅胶Silicon

温度范围Temperature range:-40°C~+85°C

颜色Color:黑色Black

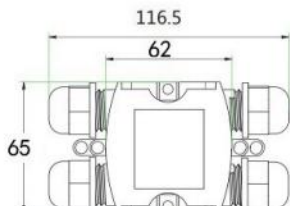
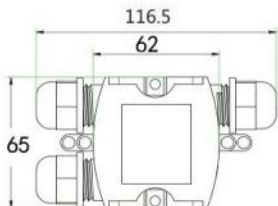
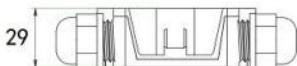

with screw terminal block

型号 No.option	盒子尺寸 Size box mm	接线范围 Cable Gland OD mm	接线方式 Wiring Method	线径 Wire Size mm <sup>2</sup>	电流/电压 A/V	防水等级 IP
305	116.5x65x29	3-6.5/ 6-10	Screw Terminal Block	0.5-1.5	17.5A/ 450V	IP68
405						

## 防水接线盒 Waterproof Box XYM24

胶壳材质Housing:PA66

导体材质Metal Part:铜Brass

防水圈材质Waterproof O-Ring:硅胶Silicon

温度范围Temperature range:-40°C~+85°C

颜色Color:黑色Black

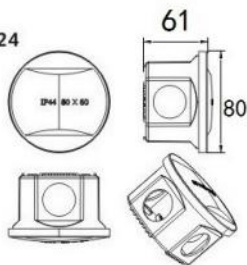

型号 No.option	盒子尺寸 Size box mm	接线范围 Cable Gland OD mm	接线方式 Wiring Method	线径 Wire Size mm <sup>2</sup>	电流/电压 A/V	防水等级 IP
413	128X128X61	12-15	Quick Connector	0.5-1.5	17.5A/ 450V	IP55

# 防水接线盒 Waterproof Box XYM25

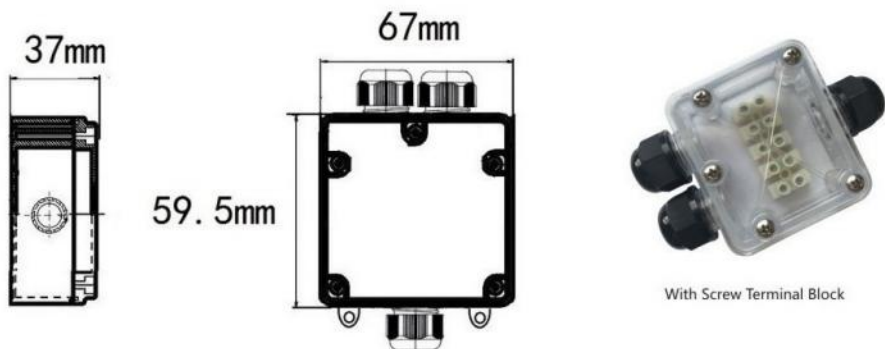

With Screw Terminal Block

胶壳材质Housing:PC

导体材质Metal Part:铜Brass

防水圈材质Waterproof O-Ring:硅胶Silicon

温度范围Temperature range:-40°C~+85°C

颜色Color:透明

No.	型号 No.option	盒子尺寸 Size box mm	接线范围 Cable Gland OD mm	接线方式 Wiring Method	线径 Wire Size mm <sup>2</sup>	电流/电压 A/V	防水等级 IP
	305	114x67x36	3-6.5/ 6-10	Screw Terminal Block	0.5-2.5	24A/450V	IP68
	405	114x95.5x36					
	505	114x112.5x36					

# 防水接线盒 Waterproof Box XYPG9-M2068

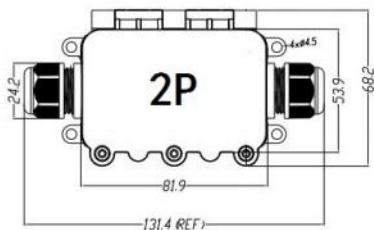
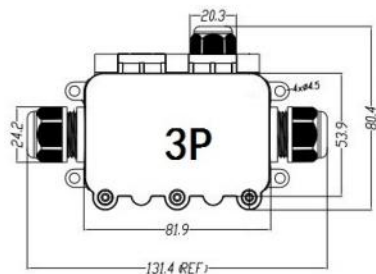
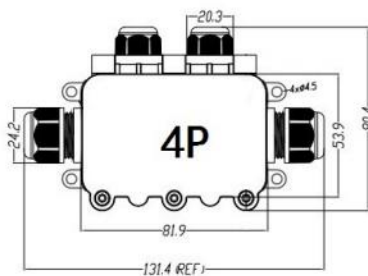
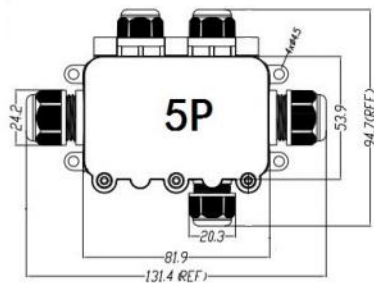
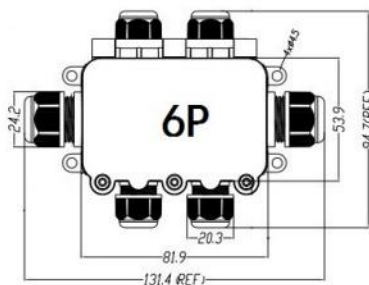
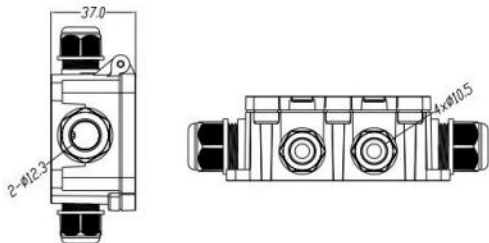

胶壳材质Housing:PA66

防水圈材质Waterproof O-Ring:硅胶Silicon

温度范围Temperature range:-40°C~+85°C

颜色Color:黑色Black

## 防水接线盒 Waterproof Box

### XYPG9-M2069: 2P/3P/4P/5P/6P/7P/8P

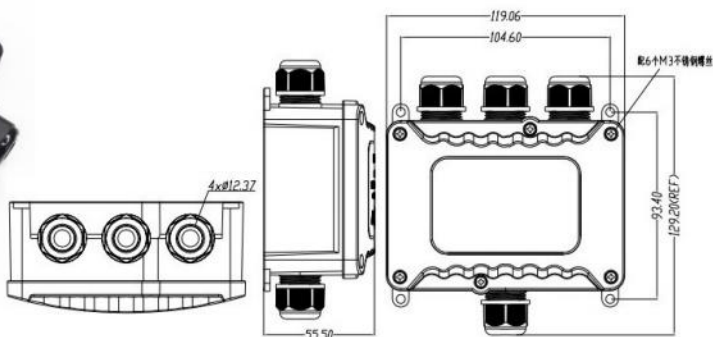

### XYPG9-M2067: 2P/3P/4P/5P/6P/7P/8P

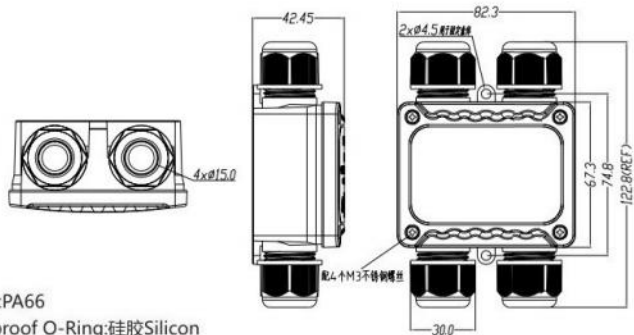
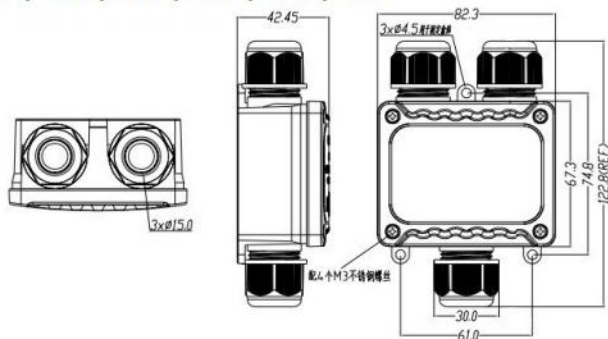

胶壳材质Housing:PA66

防水圈材质Waterproof O-Ring:硅胶Silicon

温度范围Temperature range:-40°C~+85°C

颜色Color:黑色Black

# ABS防水接线盒 ABS Waterproof Box



型号NO.	长度L	直径φ	高度H
55X90X115	50mm	90mm	115mm
75X120X200	75mm	120mm	200mm
67X120X200	67mm	120mm	200mm
60X90X158	60mm	90mm	158mm
58X90X115	58mm	90mm	115mm
50X68X100	50mm	68mm	100mm
90X160X160	90mm	160mm	160mm
85X150X230	85mm	150mm	230mm
33X58X230	33mm	58mm	230mm
33X58X83	33mm	58mm	83mm
35X58X63	35mm	58mm	63mm
70X188X192	70mm	188mm	192mm



型号NO.	直径φ	高度H
50x50	50mm	50mm
80x50	80mm	50mm



型号NO.	长度L	直径φ	高度H
85x85x50	85mm	85mm	50mm
100x100x70	100mm	100mm	70mm
150x110x70	150mm	110mm	70mm
150x150x70	150mm	150mm	70mm
200x100x70	200mm	100mm	70mm
200x155x80	200mm	155mm	80mm
200x200x80	200mm	200mm	80mm
255x200x80	255mm	200mm	80mm
300x250x120	300mm	250mm	120mm
400x350x120	400mm	350mm	120mm



型号NO.	长度L	直径φ	高度H
95x65x55	95mm	65mm	55mm
110x80x70	110mm	80mm	70mm
110x80x85	110mm	80mm	85mm
100x100x75	100mm	100mm	75mm
100x100x100	100mm	100mm	100mm
130x80x70	130mm	80mm	70mm
130x80x85	130mm	80mm	85mm
180x80x70	180mm	80mm	70mm
200x200x100	200mm	200mm	100mm
250x80x70	250mm	80mm	70mm
250x80x85	250mm	80mm	85mm
125x125x100	125mm	125mm	100mm
125x125x75	125mm	125mm	75mm
175x125x100	175mm	125mm	100mm
170x140x95	170mm	140mm	95mm
175x175x100	175mm	175mm	100mm
200x150x100	200mm	150mm	100mm
250x150x100	250mm	150mm	100mm
280x190x130	280mm	190mm	130mm

## 铝压铸防水接线盒 Aluminum die-cast Waterproof Box



型号NO.	长度L	直径φ	高度H
64x58x35	64mm	58mm	35mm
120x80x55	120mm	80mm	55mm
135x85x56	135mm	85mm	56mm
125x80x58	125mm	80mm	58mm
188x120x78	188mm	120mm	78mm
100x68x50	100mm	68mm	50mm
111x64x37	111mm	64mm	37mm
180x140x37	180mm	140mm	37mm
90x36x31	90mm	36mm	31mm
228x150x75	228mm	150mm	75mm
200x130x75	200mm	130mm	75mm
185x135x85	185mm	135mm	85mm
220x155x95	220mm	155mm	95mm
250x185x88	250mm	185mm	88mm
280x185x80	280mm	185mm	80mm

## 防水接线盒 Waterproof Box XYM16

外壳材质Housing:PA66

导体材质Metal Part:铜Brass

防水圈材质Waterproof O-Ring:硅胶Silicon

温度范围Temperature range:-40°C~+85°C

颜色Color:黑色Black

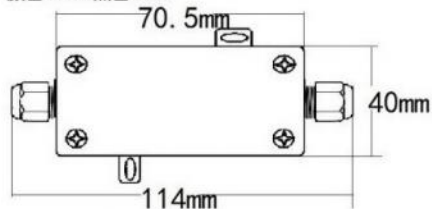

型号 No.option	盒子尺寸 Size box mm	接线范围 Cable Gland OD mm	接线方式 Wiring Method	线径 Wire Size mm	电流/电压 A/V	防水等级 IP
203	114x40x29		Screw Terminal Block	0.5-2.5	24A/450V	IP65
213		4-8	Quick Connector			

# 公母对插端子 IP20

Knife Switches-Disconnecting Devices

M29-W01  
NO. : 2P/3P

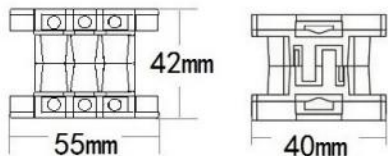

M29-B01  
NO. : 2P/3P

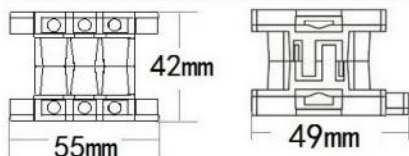

M29-W01  
NO. : 4P/5P

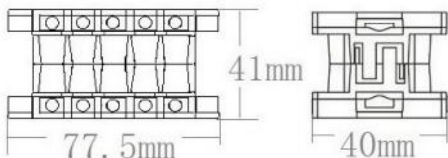

M29-W02 (Small)  
NO. : 2P/3P

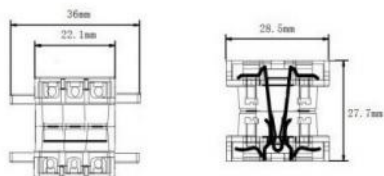

胶壳材质Housing: PA

五金材质Metal Material: 铜Brass

环境温度Temperature:  $-40^{\circ}\text{C}$  to  $+85^{\circ}\text{C}$

欧洲标准Eropre Stander:

450V 16A 0.5~2.5/4.0mm<sup>2</sup>

美国标准USA Stander:

450V/300V 16A 18-12AWG

中国标准China Stander:

10A 250V~ 0.5~2.5mm<sup>2</sup>

## GST18-2P(SS)

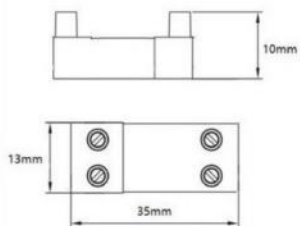

## GST18-2P(H)

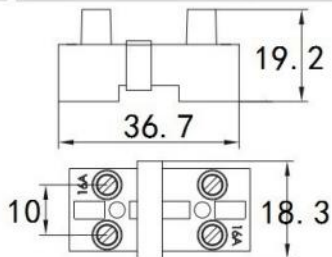

## GST18-3P(H)

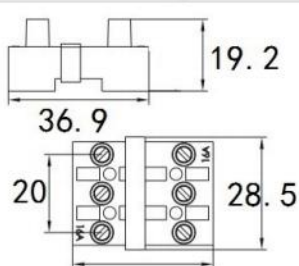

## GST18-4P(H)

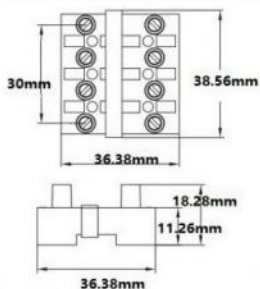

## GST18-2P

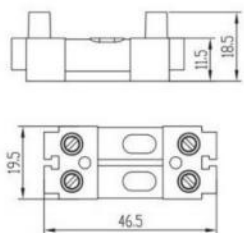

## GST18-3P 36.9

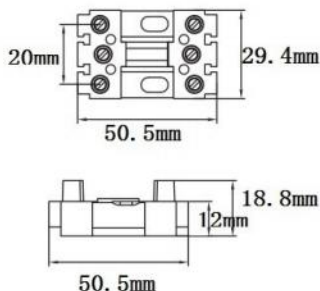

## GST18-4P

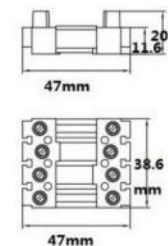

胶壳材质Housing: PA  
 五金材质Metal Material: 铜Brass  
 环境温度Temperature:  $-40^{\circ}\text{C}$  to  $+85^{\circ}\text{C}$   
 欧洲标准Europe Stander:  
 450V 16A 0.5 $\sim$ 2.5/4.0mm $^2$   
 美国标准USA Stander:  
 450V 16A 18-12AWG  
 中国标准China Stander:  
 10A 250V $\sim$ 0.5 $\sim$ 2.5mm $^2$

# 插拔式接线端子系列 Pluggable Terminal block

## GST18-5P

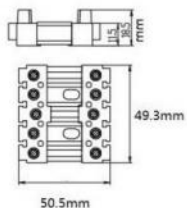

## GST18-2P(DS)

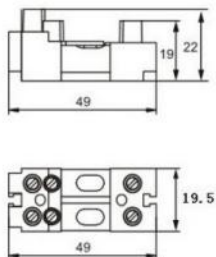

## GST18-3P(DS)

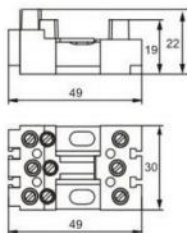

## GST18-4P(DS)

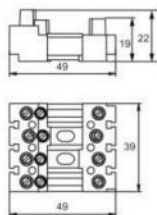

## GST18-5P(DS)

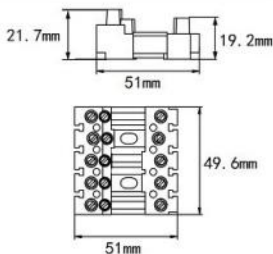

## GST18-2P(DD)

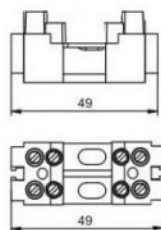

## GST18-3P(DD)

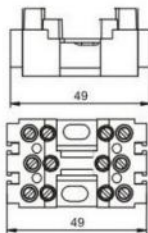

胶壳材质Housing: PA  
 五金材质Metal Material: 铜Brass  
 环境温度Temperature:  $-40^{\circ}\text{C}$  to  $+85^{\circ}\text{C}$   
 欧洲标准Europe Stander:  
 450V 16A 0.5~2.5/4.0mm<sup>2</sup>  
 美国标准USA Stander:  
 450V 16A 18-12AWG  
 中国标准China Stander:  
 10A 250V~ 0.5~2.5mm<sup>2</sup>

# 插拔式接线端子系列 Pluggable Terminal block

## GST18-4P(DD)

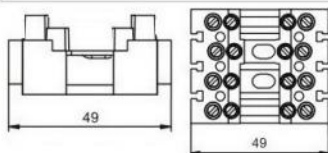

## GST18-5P(DD)

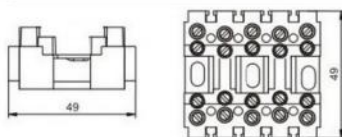

## GST18-2P(CC)

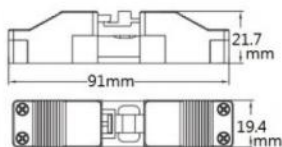

## GST18-3P(CC)

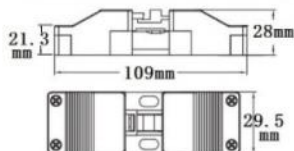

## GST18-4P(CC)

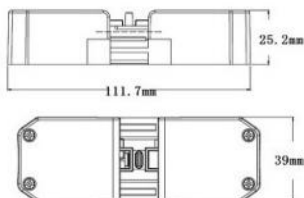

## GST18-5P(CC)

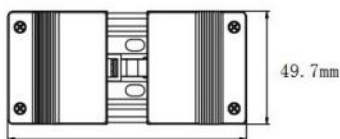

109mm

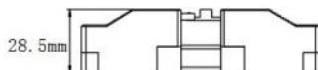

28.5mm

胶壳材质Housing: PA

五金材质Metal Material: 铜Brass

环境温度Temperature:  $-40^{\circ}\text{C}$  to  $+85^{\circ}\text{C}$

欧洲标准Erope Stander:

450V 16A  $0.5\sim 2.5/4.0\text{mm}^2$

美国标准USA Stander:

450V/300V 16A 18-12AWG

中国标准China Stander:

10A 250V  $0.5\sim 2.5\text{mm}^2$

# 插拔式接线端子系列 Pluggable Terminal block

## GST18-3P(DSC)

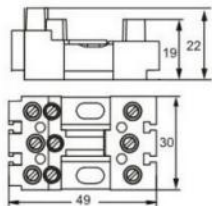

## GST18-4P(DSC)

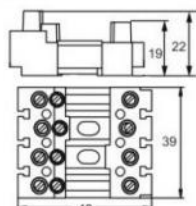

## PA12-4-3

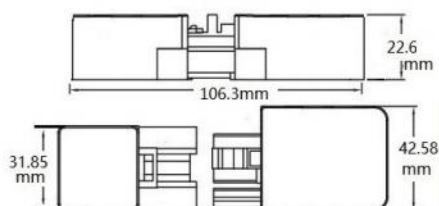

## PA12-4-3 (P02)

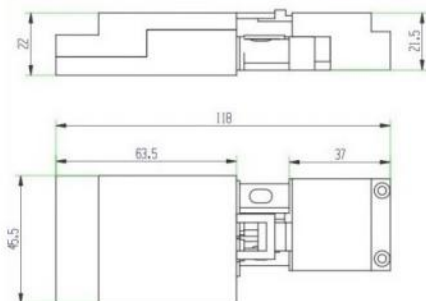

## PA12-4-3 (P02-P02)

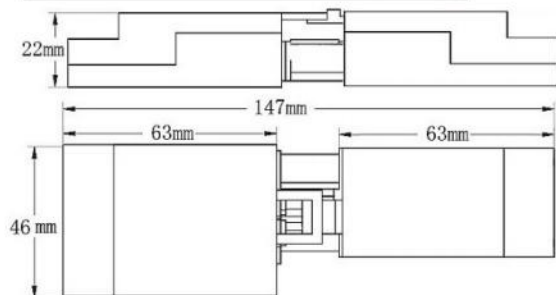

胶壳材质Housing : PA

五金材质Metal Material : 铜Brass

环境温度Temperature : -40°C to +85°C

欧洲标准Europe Stander : 450V 16A 0.5~2.5/4.0mm<sup>2</sup>

美国标准USA Stander : 450V 16A 18-12AWG

中国标准China Stander : 10A 250V~ 0.5~2.5mm<sup>2</sup>

# 插拔式接线端子系列 Pluggable Terminal block

## XY GST18-5



## XY GST18-3

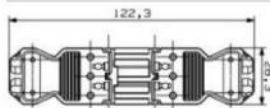

## XY GST18-3(T)转换头 Transfer head



## XY GST18-3(F)带翅膀 With wing



## XY GST18-3带插头 With Plug



胶壳材质Housing : PA

五金材质Metal Material : 铜Brass

环境温度Temperature : -40°C to +85°C

欧洲标准Euro Stander : 450V 16A 0.5~2.5/4.0mm<sup>2</sup>

美国标准USA Stander : 450V 16A 18-12AWG

中国标准China Stander : 10A 250V~ 0.5~2.5mm<sup>2</sup>

# LED灯对插连接器

Luminaire Disconnect

## CN-1



品名: 燈具連接器  
額定: 3A120V/1.3A277VAC  
1.04A347VAC/0.75A480VAC  
材質: 塑膠

Name: Luminaire Disconnect  
Rating: 3A120V/1.3A277VAC  
1.04A347VAC/0.75A480VAC  
Material: Plastic Base

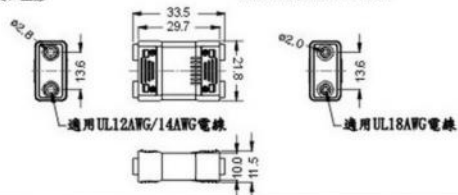

## CN-2



品名: 燈具連接器  
額定: 3A120V/1.3A277VAC  
1.04A347VAC/0.75A480VAC  
材質: 塑膠

Name: Luminaire Disconnect  
Rating: 3A120V/1.3A277VAC  
1.04A347VAC/0.75A480VAC  
Material: Plastic Base

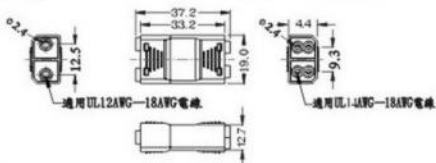

## CN-3



品名: 燈具連接器  
額定: 3A120V/1.3A277VAC  
1.04A347VAC/0.75A480VAC  
材質: 塑膠

Name: Luminaire Disconnect  
Rating: 3A120V/1.3A277VAC  
1.04A347VAC/0.75A480VAC  
Material: Plastic Base

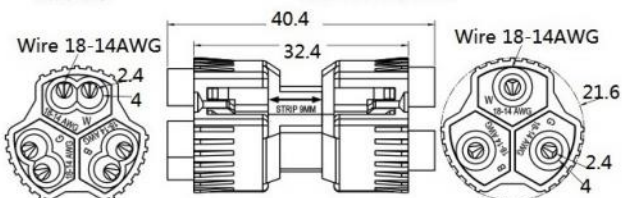

## CN-011



Name : Luminaire Disconnect

品名: 燈具連接器

額定(Rating) : 3A 120V / 1.3A 277VAC  
1.04A 347VAC / 0.75A 480VAC  
0.6A 600V / 6A 600V

材質: 塑膠

Material : Plastic Base

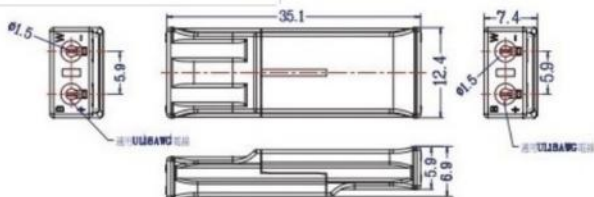

# LED灯对插连接器 182

Luminaire Disconnect



2-4



3-6

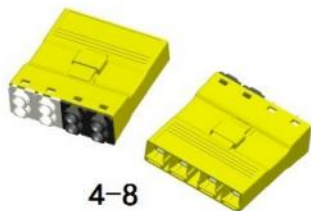

4-8

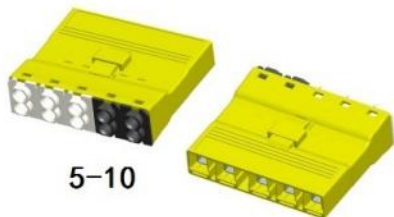
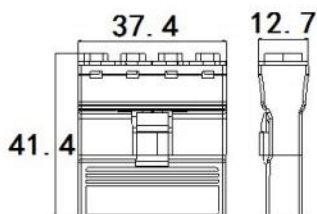
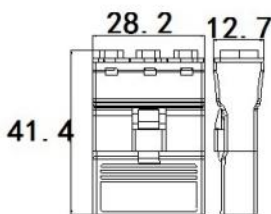
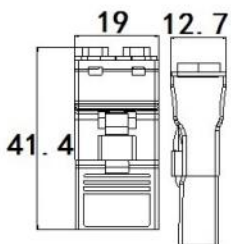

5-10

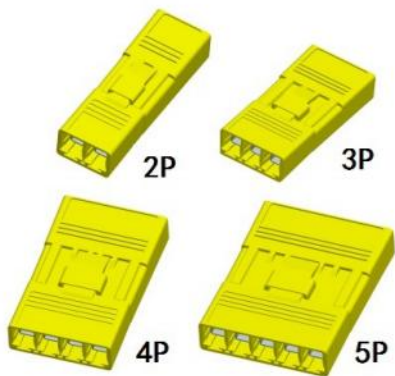

2P

3P

4P

5P

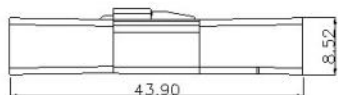
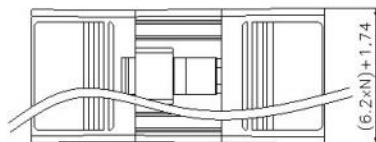
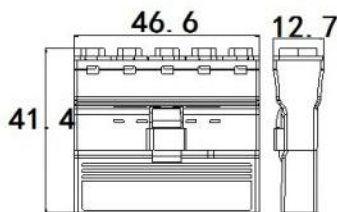

胶壳材质Housing: PA

夹件件材质Metal Part: 铜brass

额定工作电压Rated voltage: 600V

额定工作电流Rated current: 6A

额定连接容量Cable range: 24-12AWG

环境温度temperature: -40°C to +85°C

# LED灯对插连接器

## Luminaire Disconnect



182A-3P

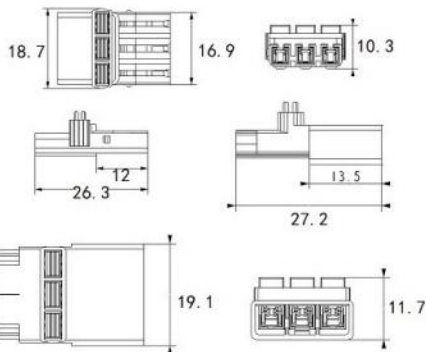

182A-2P

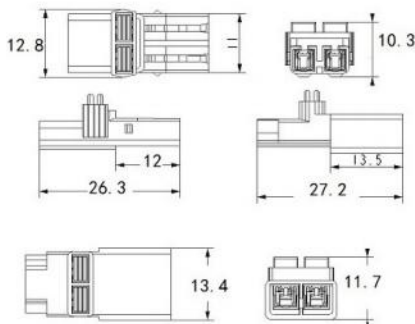

182B-3P

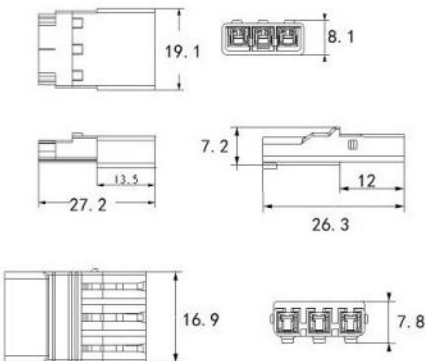

182B-2P

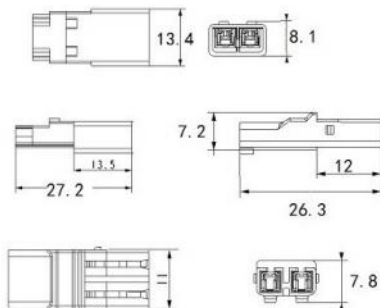

胶壳材质Housing: PA

夹件材质Metal Part: 铜brass

额定工作电压Rated voltage: 600V

额定工作电流Rated current: 3A

额定连接容量Cable range: 18AWG

环境温度temperature: -40°C to +85°C

# 开关 Switch

## 303



胶壳材质Housing : PA  
五金材质Metal Material : 铜Brass

环境温度Temperature :  
-40°C to +85°C

欧洲标准Eropre Stander :  
250V 2A 0.75mm<sup>2</sup>

美国标准USA Stander :  
125V 3A 18AWG

中国标准China Stander :  
250V 2A 0.75mm<sup>2</sup>

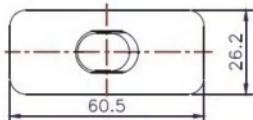

## 304



欧洲标准Eropre Stander :  
250VAC 2A 0.75mm<sup>2</sup>  
美国标准USA Stander :  
50VDC 1A 18AWG  
中国标准China Stander :  
250VAC 2A 0.75mm<sup>2</sup>

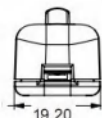
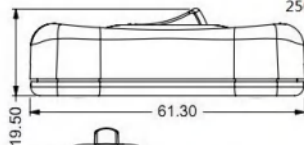

胶壳材质Housing : PA  
五金材质Metal Material : 铜Brass  
环境温度Temperature : -40°C to +85°C

## 317



胶壳材质Housing : PA  
五金材质Metal Material : 铜Brass  
环境温度Temperature : -40°C to +85°C

欧洲标准Eropre Stander :

250V 2A 0.75mm<sup>2</sup>

美国标准USA Stander :

125V 3A 18AWG

中国标准China Stander :

250VAC 2A 0.75mm<sup>2</sup>

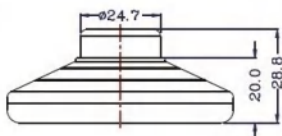
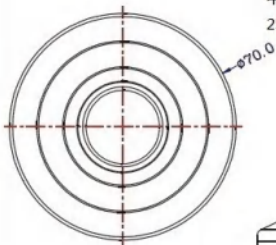

## 301



胶壳材质Housing : PA  
五金材质Metal Material : 铜Brass  
环境温度Temperature :  
-40°C to +85°C

欧洲标准Eropre Stander :

250V 1A 0.75mm<sup>2</sup>

美国标准USA Stander :

-

中国标准China Stander :  
250VAC 1A 0.75mm<sup>2</sup>

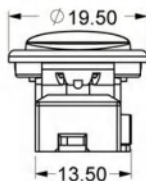
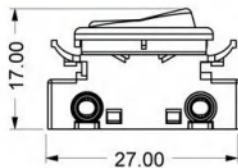

## KS-1(S)

单切

## KS-1(D)

双切



胶壳材质Housing : PA  
五金材质Metal Material : 铜Brass  
环境温度Temperature :  
-40°C to +85°C

欧洲标准Eropre Stander :

250V 2A 0.75mm<sup>2</sup>

美国标准USA Stander :

125V 3A 18AWG

中国标准China Stander :

250V 2A 0.75mm<sup>2</sup>

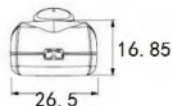
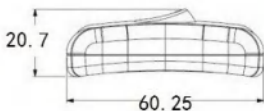

# 防水开关 Waterproof Switch 107



材质Material: 塑胶上壳, 电木底座  
Plastic upper housing, Bakelite Base

绝缘电阻Insulation Resistance(MΩ) : 100  
防水等级IP Grade : IP67  
工作电压Working Voltage ( V ) :250  
工作电流Working Current ( A ) : 3  
额定发热电流Rated thermal current ( A ) : 6  
接触电阻Contact Resistance ( Ω ) : 50

应用于户外灯具、交通信号灯  
Applied to outdoor Lamps\traffice light,etc.

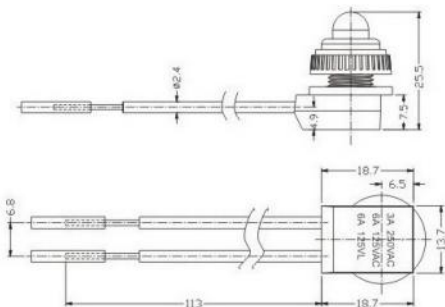

# 防水开关 Waterproof Switch RK-01

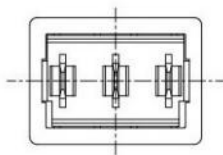
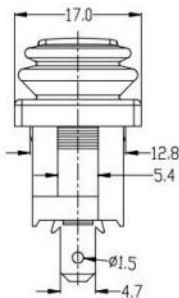
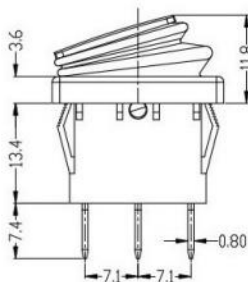
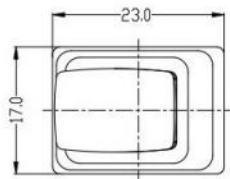

Wiring Diagram

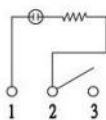

额定Rating : 8A 250VAC / 16A 125VAC

材质Material : 塑膠本體Plastic Base

# 拨动开关Slide Switch

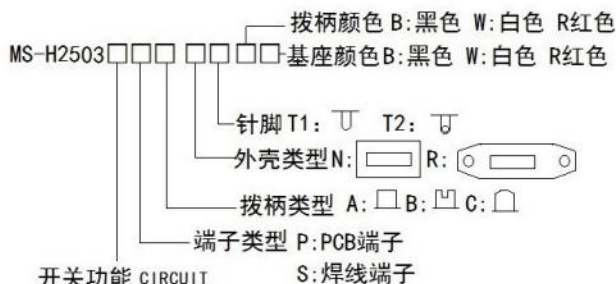

☒ 拨柄高度 : 4/5/6/7/8/9/10/11/12/13/14mm  
 (按客户要求选择)

开关功能 CIRCUIT

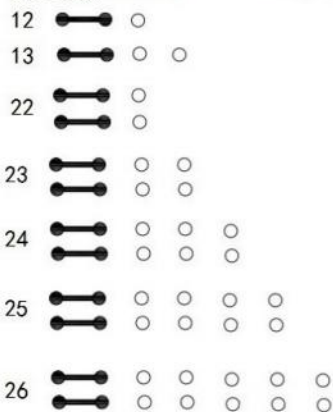

MS-H250312PC-NT1RB-(X)

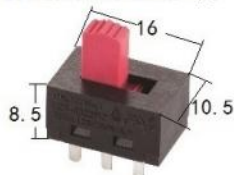

MS-H250313PC-NT1BB-(X)

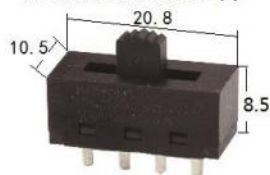

MS-H250324PC-NT1BB-(X)

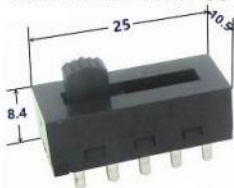

MS-H2503225-NT1BB-(X)

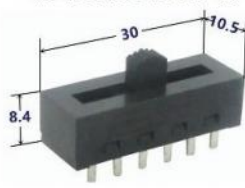

MS-H250322SC-NT1WW-(X)

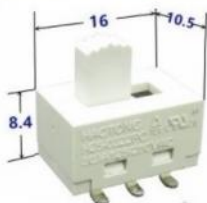

MS-H250312PC-NT2BB-(X)

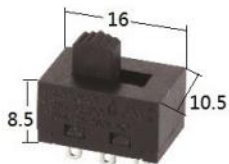

胶壳材质Housing: PA  
 五金材质Metal Material: 铜Brass  
 环境温度Temperature: -40° C to +85° C  
 额定: 3 (3A) 125VAC

MS-H250323SC-NT1WW-(X)

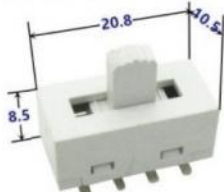







MS-H250322PC-RT2BB-(X)



MS-H250323PC-RT2BB-(X)





# 拨动开关Slide Switch





MS-SS2    G5—拨柄高度5mm  
 拨柄类型 E  R  V 

外壳类型

A: 塑料  E: 金属

B: 塑料  F: 金属

C: 塑料 

PCB端子 B  D  E  T   
 焊线端子 C 

胶壳材质Housing: PA

五金材质Metal Material: 铜Brass

环境温度Temperature: -40° C to +85° C

额定: 6 (2) A 3 (2) A 250/125VAC

开关功能  
CIRCUIT

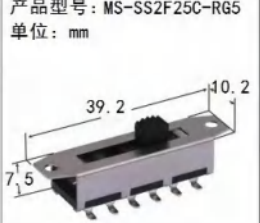
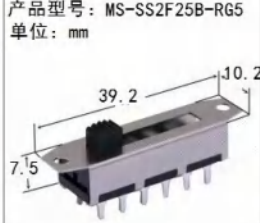
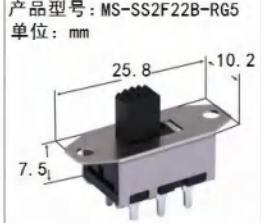
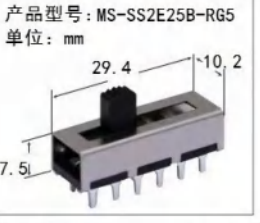
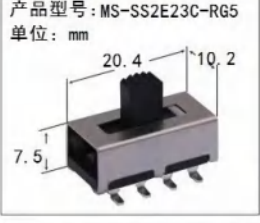
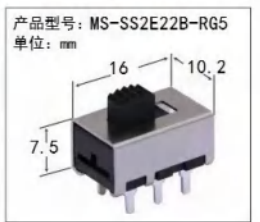
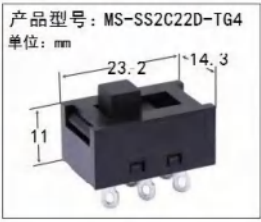
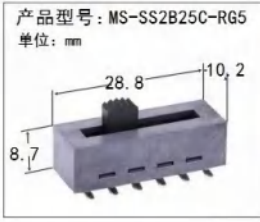
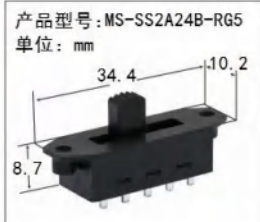
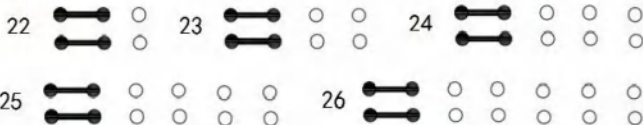



# XY-LP 全系列 XY-LP Series Device Connector

XY-LP20系列连接器设计高精度、高质量的自动插入。集自锁装置和防水防尘等特点，被广泛用于各种具有挑战性的环境。

如LED屏幕、视听设备、医疗设备、工业控制、测试和测量设备、AV系统等。

The XY-LP20 series connectors are designed with high precision, high quality automatic insertion, integrated self-locking device, water and dust resistance, and are widely used in a variety of challenging environments.

Such as LED screens, audio-visual equipment, medical equipment, industrial control, test and measurement equipment, AV systems, etc.



### 外形尺寸 Dimension Drawing (mm)

类别 Category	S端 S-terminal		L端 L-terminal		法兰 Flange		面板 Panel	
图示 Diagram								
	A	B	A	B	A	B	A	B
XY-LP12	24.6	47.0	19.3	48.4	24.4	20.8	24.4	19.3
XY-LP16	32.2	57.5	25.5	56.3	29.9	31.5	29.9	25.5
XY-LP20	38.0	70.0	31.8	70	35.7	38.0	35.7	31.8
XY-LP24	40.5	73.4	35.0	72.3	37.4	36.8	37.4	35.0
XY-LP28	53.0	86.4	43.0	87.2	52.3	43.0	52.3	43.0

### 面板/法兰安装尺寸 Dimension Drawing (mm)

	面板安装 Panel Mounting Rear		法兰安装 Flange Mounting			
图示 Diagram						
	phi A	B	phi C	phi D	A	B
XY-LP12	phi 12.0 <sup>+0.20</sup> / <sub>-0.00</sub>	11.5 <sup>+0.20</sup> / <sub>-0.00</sub>	phi 2.30 <sup>+0.20</sup> / <sub>-0.00</sub>	phi 12.0 <sup>+0.20</sup> / <sub>-0.00</sub>	13.0±0.1	13.0±0.1
XY-LP16	phi 18.5 <sup>+0.20</sup> / <sub>-0.00</sub>	16.5 <sup>+0.20</sup> / <sub>-0.00</sub>	phi 3.20 <sup>+0.20</sup> / <sub>-0.00</sub>	phi 16.5 <sup>+0.20</sup> / <sub>-0.00</sub>	20.0±0.1	20.0±0.1
XY-LP20	phi 22.5 <sup>+0.20</sup> / <sub>-0.00</sub>	20.0 <sup>+0.20</sup> / <sub>-0.00</sub>	phi 3.20 <sup>+0.20</sup> / <sub>-0.00</sub>	phi 21.0 <sup>+0.20</sup> / <sub>-0.00</sub>	22.0±0.15	22.0±0.15
XY-LP24	phi 25.2 <sup>+0.20</sup> / <sub>-0.00</sub>	24.2 <sup>+0.20</sup> / <sub>-0.00</sub>	phi 3.20 <sup>+0.20</sup> / <sub>-0.00</sub>	phi 24.0 <sup>+0.20</sup> / <sub>-0.00</sub>	26.0±0.1	26.0±0.1
XY-LP28	phi 29.5 <sup>+0.20</sup> / <sub>-0.00</sub>	28.0 <sup>+0.20</sup> / <sub>-0.00</sub>	phi 3.20 <sup>+0.20</sup> / <sub>-0.00</sub>	phi 28.0 <sup>+0.20</sup> / <sub>-0.00</sub>	28.0±0.1	28.0±0.1

## XY-LP12

电源Power supply: 2/3/4/5Pin

信号Signal: 6/7/8Pin



### 产品性能 Specifications

产品名称	Number of Poles	2Pin	3Pin	4Pin	5Pin	6Pin	7Pin	8Pin	
焊线接触件	Soldering Contact part	φ1.0*2	φ1.0*3	φ1.0*4	φ1.0*5	φ1.0*6	φ0.8*7	φ0.8*8	
锁线接触件	Screw Contact part	φ1.0*2	φ1.0*3	×	×	×	×	×	
接线范围	Wire Section	0.34~0.5mm <sup>2</sup> /22-20AWG					0.34mm <sup>2</sup> /22AWG		
额定电压	Rated Voltage	125V					100V		
额定电流	Rated Current	5A					3A		
耐压	Puncture test	1500V					1000V		
接触阻抗	Contact resistance	≤5.0mΩ					≤5.0mΩ		
温升	Temperature rise	5A 30K ↓					3A 30K ↓		
绝缘阻抗	Insulation resistance	≥1000MΩ							
环境温度	Temperature Range	-40°C~+80 °C							
高温老化	High temperature aging	85°C 168H							
插拔次数	Mating Cycle	1900次 Mating Cycles							
防水等级	IP Code	IP68 (2m /2H)							
外线直径	Outer Cable Diameter	适用OD范围Applicable OD range (φ3.0~φ6.0)mm							

## XY-LP16

电源Power supply: 2/3/4Pin

信号Signal: 5/7/8/9Pin、RJ45、光纤Optical fiber

数据Data: Type-C



### 产品性能 Specifications

产品名称	Number of Poles	2Pin	3Pin	4Pin	5Pin	7Pin	8Pin	9Pin
接触件	Contact part	φ1.5*2	φ1.5*3	φ1.5*4	φ1.0*5	φ1.0*7	φ1.0*8	φ1.0*9
接线范围	Wire Section	1~1.5mm <sup>2</sup> /18~16AWG			0.34~0.75mm <sup>2</sup> /22~20AWG			
额定电流	Rated Current	10A			5A			
工作电压	Withstand voltage	500V			250V			
耐压	Puncture test	2000V			1500V			
接触阻抗	Contact resistance	≤3.0mΩ			≤5.0mΩ			
温升	Temperature rise	10A 30K ↓			5A 30K ↓			
绝缘阻抗	Insulation resistance	≥1000MΩ						
环境温度	Temperature Range	-40°C ~ +80 °C						
高温老化	High temperature aging	85°C 168H						
插拔次数	Mating Cycle	1900次 Mating Cycles						
防水等级	IP Code	IP68 (2m /2H)						
外线直径	Outer Cable Diameter	适用OD范围φ4.0-φ9.0mm						

## XY-LP20

电源Power supply: 2/3/4Pin

信号Signal: 5/7/9/12Pin



### 产品性能 Specifications

产品名称	Number of Poles	2Pin	3Pin	4Pin	5Pin	7Pin	9Pin	12Pin
焊线接触件	Soldering Contact part	φ2.7*2	φ2.7*3	φ2.7*4	φ1.8*5	φ1.8*7	φ1.0*9	φ1.0*12
锁线接触件	Screw Contact part	φ2.4*2	φ2.4*3	φ2.4*4	φ1.8*5	×	×	×
接线范围	Wire Section	2.5~4mm <sup>2</sup> /14~12AWG			1~1.5mm <sup>2</sup> /18~16AWG		0.34~0.75mm <sup>2</sup> /22~20AWG	
额定电流	Rated Current	20A			10A		5A	
接触阻抗	Contact resistance	<1mΩ			<3mΩ		<5mΩ	
工作电压	Operating voltage	500V			250V			
温升	Temperature rise	20A 30K ↓; 25A 40K ↓; 30A 50K ↓			10A 30K ↓; 15A 40K ↓; 20A 50K ↓		5A 30K ↓; 7A 40K ↓; 10A 50K ↓	
耐压	Puncture test	2500V			1500V			
绝缘电阻	Insulation resistance	≥1000 MΩ						
机械寿命	Mating Cycle	1900次						
环境温度	Temperature Range	-40°C ~ +80 °C						
高温老化	High temperature aging	85 °C / 168 H						
防水等级	IP Code	IP68 (2m /2H)						
外线直径	Outer Cable Diameter	常规电源类φ8~12mm 常规信号类φ5~6.5mm 其他φ5~9mm						

## XY-LP24

电源Power supply: 2/3/4Pin  
 信号Signal: 10/12/19/24Pin、RJ45、光纤Optical fiber  
 数据Data: USB、HDMI



### 产品性能 Specifications

产品名称 Number of Poles	2Pin	3Pin	4Pin	10Pin	12Pin	19Pin	24Pin
焊线接触件 Soldering Contact part	φ3.0*2	φ3.0*3	φ3.0*4	φ1.5*10	φ1.5*12	φ1.0*19	φ1.0*24
锁线接触件 Screw Contact part	φ3.0*2	φ3.0*3	φ3.0*4	x	x	x	x
接线范围 Wire Section	4mm <sup>2</sup> /12AWG		1.5mm <sup>2</sup> /16AWG		0.5mm <sup>2</sup> /20AWG		
额定电压 Rated Voltage	500V		400V		250V		
额定电流 Rated Current	30A		10A		5A		
耐压 Puncture test	2500V		1500V		1000V		
接触阻抗 Contact resistance	≤1.0mΩ		≤3.0mΩ		≤5.0mΩ		
温升 Temperature rise	30A 30K↓; 35A 40K↓; 40A 50K↓		10A 30K↓; 15A 40K↓; 20A 50K↓		5A 30K↓; 7A 40K↓; 10A 50K↓		
绝缘电阻 Insulation resistance	≥1000MΩ						
环境温度 Temperature Range	-40°C~+80°C						
高温老化 High temperature aging	85°C 168H						
插拔次数 Mating Cycle	1900次 Mating Cycles						
防水等级 IP Code	IP68 (2m/2H)						
外线直径 Outer Cable Diameter	(φ9.5-φ14.0mm)						

## XY-LP24

### 数据及特殊信号类

\*注: ① (针对VBUS和GND接触PIN)  
 ② (针对所有其他接触PIN)



### 产品性能 Specifications

产品名称 Product name	EW-LP24-USB	EW-LP24-HDMI	EW-LP24-RJ45	EW-LP24-FIBER
额定电压 Rated Voltage	30V	40V	125V	/
额定电流 Rated Current	1.8A ①/0.25A ②	0.5A	1.5A	/
耐压 Puncture test	100V	500V	1000V	/
接触阻抗 Contact resistance	≤30mΩ ① ≤30mΩ ②	≤30mΩ	≤30mΩ	/
绝缘电阻 Insulation resistance	>100MΩ	>100MΩ	>500MΩ	/
环境温度 Temperature Range	-40°C ~ 80°C			
高温老化 High temperature aging	85°C 168H			
插拔次数 Mating Cycle	1900次 Mating Cycle			
防水等级 IP Code	IP65 (连接状态 Connection status)			
外线直径 Outer Cable Diameter	Ø5.0mm ~ Ø6.5mm (RJ45/光纤Optical fiber) 、Ø5.0mm ~ Ø7.0mm (USB/HDMI)			

## XY-LP28

电源: 2/3/4/5芯  
 信号: 6/8芯



### 产品性能 Specifications

产品名称 Number of Poles	2P	3P	4P	5P	6P	8P
焊线接触件 Soldering Contact part	x	x	φ3.5*4	φ3.5*5	φ3.0*6	φ3.0*8
锁线接触件 Screw Contact part	φ4.0*2	φ4.0*3	φ3.5*4	φ3.5*5	x	x
接线范围 Wire Section	16mm <sup>2</sup> /6AWG	10mm <sup>2</sup> /8AWG	6mm <sup>2</sup> /9AWG	6mm <sup>2</sup> /9AWG	4.0mm <sup>2</sup> /12AWG	4.0mm <sup>2</sup> /12AWG
额定电压 Rated Voltage	500V	500V	450V	450V	300V	300V
额定电流 Rated Current	50A	35A	30A	30A	15A	15A
温升 Temperature rise	50A 30K↓	35A 30K↓	30A 30K↓	30A 30K↓	15A 30K↓	15A 30K↓
耐压 Puncture test	2500V					
接触阻抗 Contact resistance	≤1mΩ					
绝缘电阻 Insulation resistance	≥1000MΩ					
环境温度 Temperature Range	-40°C ~ +80°C					
高温老化 High temperature aging	85°C 168H					
插拔次数 Mating Cycle	1900次 Mating Cycle					
防水等级 IP Code	IP68 (2m/2H)					
外线直径 Outer Cable Diameter	(Ø13.0-Ø20.5)mm					

# 插座开关

型号MODEL : MS- M2

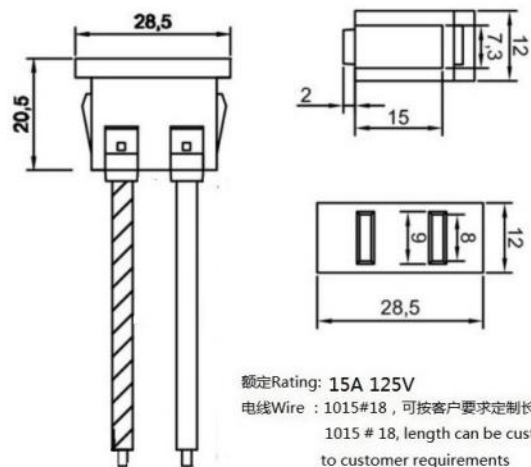

额定Rating: 15A 125V

电线Wire : 1015#18, 可按客户要求定制长度

1015 # 18, length can be customized according to customer requirements

型号MODEL : MS- M3



额定Rating: 15A 125V

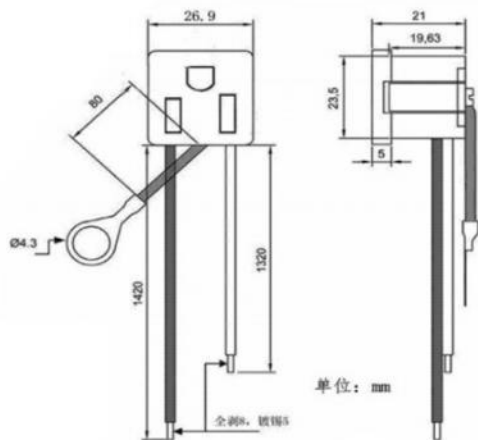
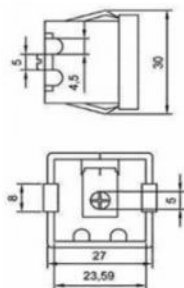

单位: mm

# USB插座开关 USB Plug Switch

型号MODEL : MS- 204

额定Rating: 5V 2A

电线Wire : 1015#18, 可按客户要求定制长度

1015 # 18, length can be customized according to customer requirements



# 灯具光控器

## PHOTOCONTROLLER



### 产品概述

适用于对路灯、庭院灯、走廊灯、门灯等照明灯具进行自动开关控制。此型光控器能依据自然界的光线强弱变化,实现昼熄夜明的控制功能。本产品设计电子线路辅助热开关,增加了红外过滤光电二极管传感器和一个避雷器(MOV)。宽电压特性扩展了光控器的强大的大功率灯载荷,不管是白炽灯,整流器灯或电子整流器灯。

除此之外,它的延时特性可以避免在晚上由于车灯或闪电造成的影响。

### Product Summary

garden lighting, passage lighting and doorway lighting automatically in accordance with the ambient natural lighting level.

This product is designed with electronic circuit assisted thermal switch, with sensor of IR filtered photodiode and a surge arrester (MOV) is available. Its multi-volts feature expands the application of thermal switch which is powerful to carry high wattage lamp loadings, regardless the loading in incandescent, ballasted or e-ballasted.

Besides, its time-delay feature might avoid mis-operation due to spotlight or lightning during the night time.

### 安装

切断电源;将光控器插座依照右图接线。

将灯具光控器旋上光控器插座,调整插座方向使灯具光控器顶部印制的朝北箭头(NORTH)指向北方。

接通电源,灯具自动点亮,约2分钟后,光控器进入工作状态。

本灯具光控器的工作不受天气晴雨、潮湿和气温变化的影响。

### Installation

Disconnect power; wire the color coded receptacle according to the diagram below.

Push the photocontroller on and twist it clockwise to lock it into the receptacle.

Install the photocontroller with the Photocell facing the NORTH direction as indicated on the top of the photocontroller.

Adjust the receptacle position if necessary.

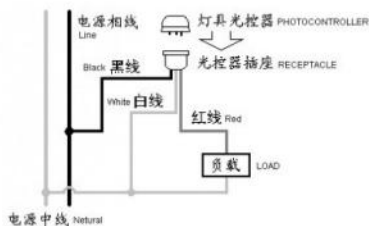

# 光控器插座 RECEPTACLE



型号 Model No.	JL-200X	JL-200	JL-200Z
外形尺寸 (mm) Overall Dimensions	65Dia.x38.5		65Dia.x65
适用电压范围 Applicable Volt Range	0~480VAC		
频率 Rated Frequency	50/60Hz		
建议负载 Suggested Loading	AWG#18: 10Amp; AWG#14: 15Amp		
环境温度 Ambient Temperature	-40°C ~ +70°C		
相对湿度 Relative Humidity	99%		
附件 Accessory	防护罩 Back/Front Cover	无	有
	锌合金螺母 Zinc Alloy Lock Nut	无	有
	安装支架 Mounting Plate/Base	无	有
引线 Leads	6" Min.		

## 安装

- 切断电源；  
(1a) 灯体安装JL-200X时，请参照右下图确定灯体预开孔。
- 依照右图连接引线：
  - 黑线接电源相线（火线）；
  - 红线接灯具（火线端或任一输入端）；
  - 白线接电源零线，并连接灯具（零线端或另一输入端）。
- 大脚对大孔、装上光控器，并顺时针方向旋转约30度至锁紧。

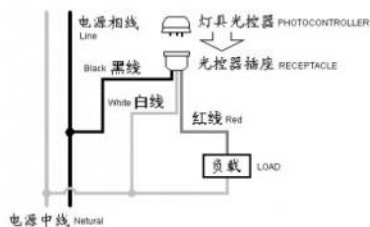

## Installation

Disconnect power; wire the receptacle according to the diagram on right hand. An arrow indicating NORTH on the top of the receptacle is used to assist correct direction. Push the photocontroller on and twist it clockwise to lock it into the receptacle. Install the photocontroller with the Photocell facing the NORTH direction as indicated on the top of the photocontroller. Adjust the receptacle position if necessary.

# 光控器插座 RECEPTACLE

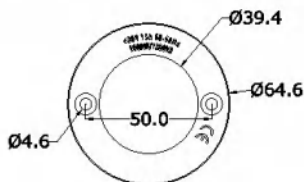
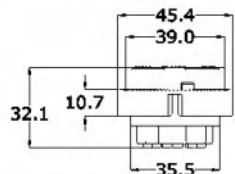

XY-GD153



(正面)

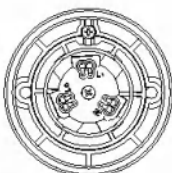

(背面)



DIY接线

XY-GD155



(正面)



(背面)



DIY接线

XY-GD157



(正面)



(背面)



DIY接线

材料: PBT增强阻燃  
 颜色: 黑色  
 电流: 480V 15A 50/60Hz  
 1000W/1800VA  
 板端开孔尺寸: 36mm  
 螺丝固定孔间距: 50mm

# USB连接器Connector

## 款式一.USB板后螺纹PCB针式

USB2.0-C-02



USB3.0-C-02

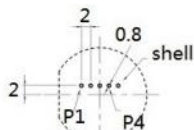
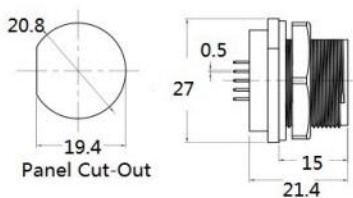

PCB板开孔尺寸

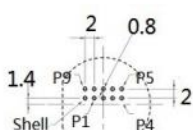

PCB板开孔尺寸

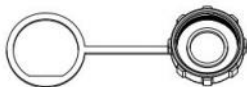

## 款式二.USB板后螺纹双母座

USB2.0-C-01



USB3.0-C-01

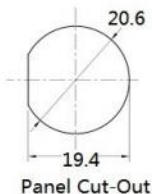

Panel Cut-Out

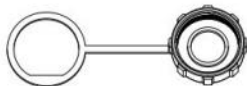
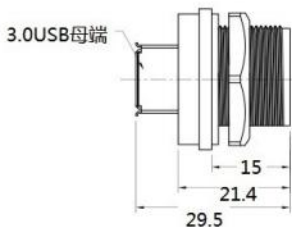
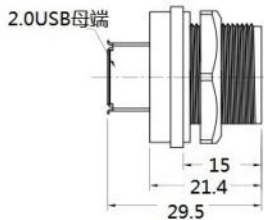

技术参数Technical parameters :

传输速率Transmission rate : 符合TIA或EIA 568B的5E类/6A类 D级/等级和符合ISO/IEC 11801

Class 5E/Class 6A, Class D/Class D, TIA or EIA 568B compliant and ISO/IEC 11801 compliant

绝缘电阻Insulation resistance :  $\geq 100M\Omega$  at DC300V

工频耐电压Power frequency withstand voltage:  $\geq AV 300V/1$  Minute

额定电流Rated current : 1.5A

防水等级Waterproof grade:IP67

接触电阻contact resistance: $\leq 30M\Omega$

# USB连接器Connector

## 款式三.USB卡扣焊线式

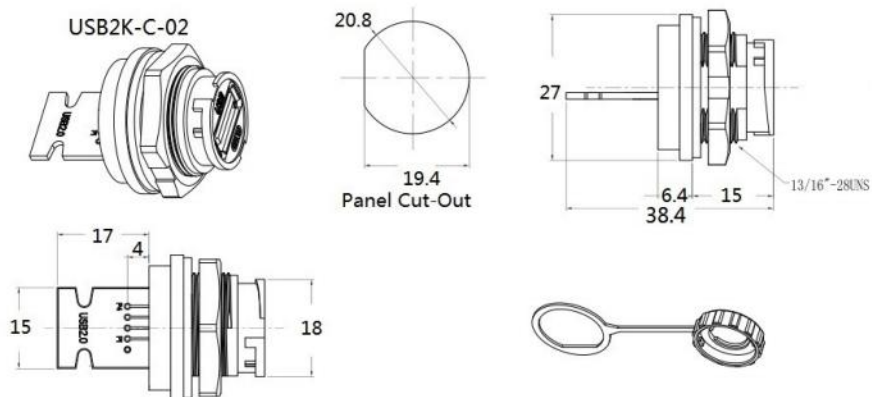

## 款式四.USB螺纹焊线式

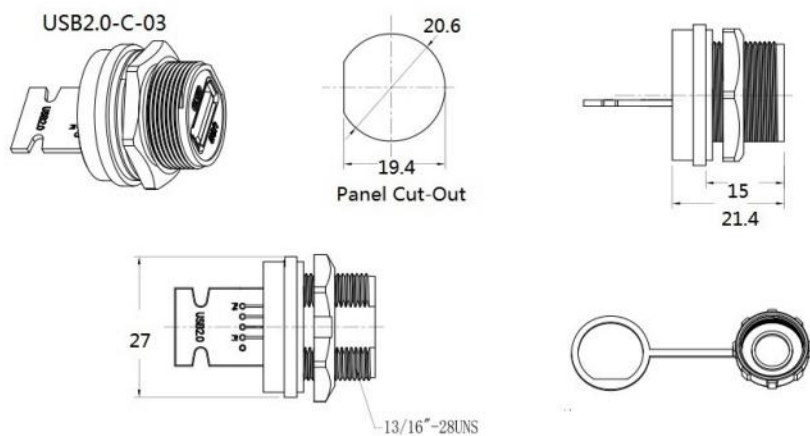

技术参数Technical parameters:

传输速率Transmission rate: 符合TIA或EIA 568B的5E类/6A类 D级/等级和符合ISO/IEC 11801

Class 5E/Class 6A, Class D/Class D, TIA or EIA 568B compliant and ISO/IEC 11801 compliant

绝缘电阻Insulation resistance:  $\geq 100M\Omega$  at DC300V

工频耐电压Power frequency withstand voltage:  $\geq AV 300V/1$  Minute

额定电流Rated current: 1.5A

防水等级Waterproof grade:IP67

接触电阻contact resistance: $\leq 30M\Omega$

# 端子台 Terminal Block

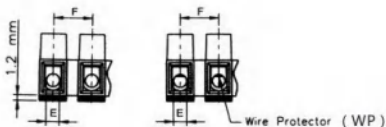
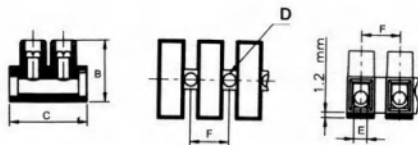
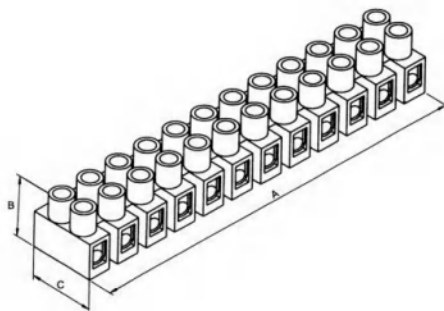

Model 型号	mm <sup>2</sup> 线径	Amp 安培	Volt 电压	Screw 螺丝	尺寸Dimensions						Packing	
					Unit	A	B	C	D	E	F	包装
CA8F	2.5	17.5	450	M3X5.2	(mm)	93.5	12.3	17.7	2.9	2.9	8	50Pcs/Box. 10 Boxes/carton
CA8FWP	2.5	17.5	450	M3X5.2	(mm)	93.5	12.3	17.7	2.9	2.9	8	
CA8H	2.5	17.5	450	M3X5.2	(mm)	93.5	15.5	17.7	2.9	2.9	8	
CA8HWP	2.5	17.5	450	M3X5.2	(mm)	93.5	15.5	17.7	2.9	2.9	8	
CA10F	4	24	450	M3X6	(mm)	116.5	14.5	20	3.5	3.45	10	
CA10FWP	4	24	450	M3X6	(mm)	116.5	14.5	20	3.5	3.45	10	
CA10H	4	24	450	M3X6	(mm)	116.5	16.5	20	3.5	3.45	10	
CA10HWP	4	24	450	M3X6	(mm)	116.5	16.5	20	3.5	3.45	10	
CA10HT	4	24	450	M3X6	(mm)	116.5	20.2	20	3.5	3.45	10	
CA10HTWP	4	24	450	M3X6	(mm)	116.5	20.2	20	3.5	3.45	10	
CA12H	6	41	500	M3.5X7.2	(mm)	139.5	19.5	23.8	3.6	4.2	12	50Pcs/Box. 8 Bags/carton
CA12HWP	6	41	500	M3.5X7.2	(mm)	139.5	19.5	23.8	3.6	4.2	12	
CA14H	10	57	500	M4X9	(mm)	158	25.3	25.5	4.3	5	13.5	
CA14HWP	10	57	500	M4X9	(mm)	158	25.3	25.5	4.3	5	13.5	
CA16H	16	76	500	M4X9	(mm)	169.8	20.8	28	4.3	6	14.5	
CA18H	25	101	500	M5X11	(mm)	194.4	26.5	37	4.3	7.2	16.5	

## 內容 (DESCRIPTION):

材質(housing material):高線尼龍66工程塑膠, 防火等級94V-2 94V-0(Nylon 66,UL 94V2,Natural).

溫度(working temperature): -35°C~110°C或150°C

彈片(wire protector WP)CA8,CA10,CA12,CA14,CA16,CA18彈片(CA8&CA10&CA12&CA14&CA16&CA18 with wire protector)

接線排數(poles available):12排(12 poles)

## DIY 端子台

### DIY terminal block( 17.5A and 24A)

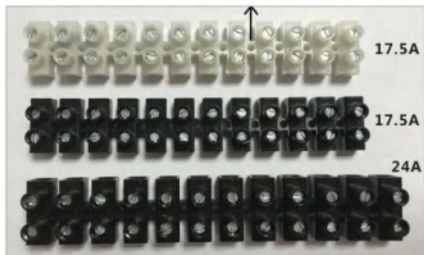

·材质housing material:PP

·底部Base:平脚Flat-bottom;

·防水等级fire rating: 94V-2 UL94V2,Natural;

·温度working temperature:-40°C~+85°C

规格Model	线径mm	安培Amp	电压Volt
17.5A	2.5	17.5	450V
24A	4.0	24	500V

## 双排接线柱

### Terminal Block with Series



·材质housing material: 高级尼龙66: Nylon66;

·防火等级fire rating: 94V-2 UL94V2,Natural;

·温度working temperature: -45°C~+110°C

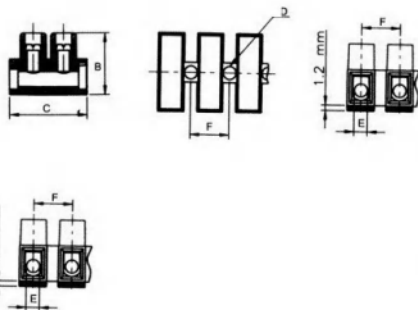
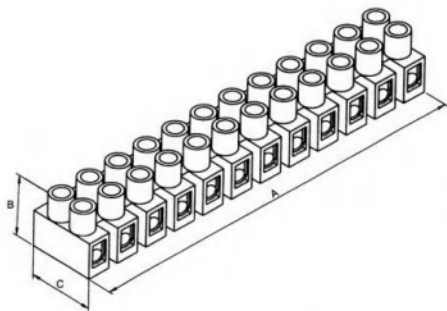

规格尺寸：

Model 型号	mm 线径	Amp 安培	Volt 电压	Screw 螺丝	尺寸Dimensions						
					Unit	A	B	C	D	E	F
8H	1.5	17.5	450	M3X5.2	(mm)	93.5	15.5	17.7	2.9	2.9	8
10H	2.5	24	450	MM3X6	(mm)	116.5	16.5	20	3.5	3.45	10
12H	6.0	41	500	M3.5X7.5	(mm)	139.5	19.5	23.8	3.6	4.2	12
14H	10.0	57	500	M4X9	(mm)	158	23.3	25.5	4.3	5	13.5
16H	16.0	76	500	M4X9	(mm)	169.8	20.8	28	4.3	6	14.5
18H	25.0	101	500	M5X11	(mm)	194.4	26.5	37	4.3	7.2	16.5

## 插拔式接线端子 Pluggable Terminal block PA12

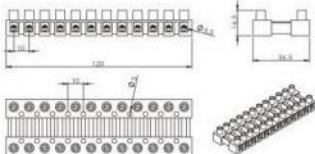

Plastic shell: PA66, (nylon 66)  
 Insert: Brass  
 Working Temperature: -40°C to 110°C  
 Current rate: 16A/450V  
 Wire size: 2.5mm<sup>2</sup>  
 Poles available: 1-12  
 Color: white

塑件: PA66  
 触件: 铜  
 温度环境: -40°C to 110°C  
 电流/电压: 16A/450V  
 电线尺寸: 2.5mm<sup>2</sup>  
 极数1-12线  
 颜色: 白色

## PC 端子台 PC Terminal Block



规格Model	经线mm	安培Amp	电压Volt
BH25(10P)	2.5	24A	450V
BH40(10P)	4.0	32A	450V
BH60(10P)	6.0	41A	450V
BH100(10P)	10.0	57A	500V

材质Housing:PC  
 防火等级fire rating:94V-2 UL94V2,Natural;  
 温度范围Temperature range:-40°C~+85°C

## 安定器端子台 (插入式) PA11 Ballast Terminal Blocks(Push-In Type)

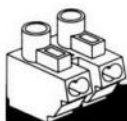

PA11-2 2 poles

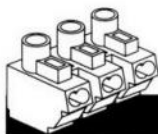

PA11-3 3 poles

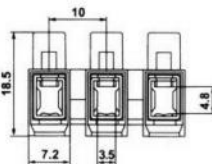
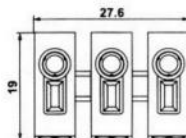
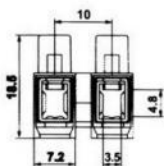
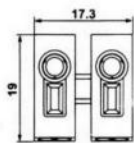
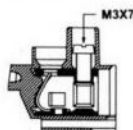
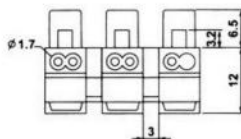
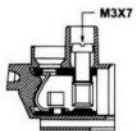
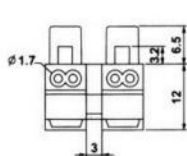

胶壳材质Housing material: PA66  
 紧固件材质Metal: 铜Brass  
 锁线弹片材质Metal: 不锈钢steel  
 额定工作电压Voltage: 450v  
 额定工作电流Ampere: 16A

额定连接容量Wiring Capacity: 0.5-2.5mm<sup>2</sup>  
 环境温度temperature: T110  
 剥线长度Strip length: 8-10mm

## 按压端子

Luminaire Pushwire Connector

规格Specifications: 1P-3P

截面Cross section 0.5-2.5mm<sup>2</sup>

颜色-白色 (Color-white)

### CH-2

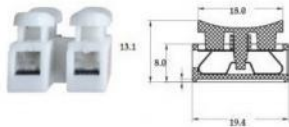

### CH-3

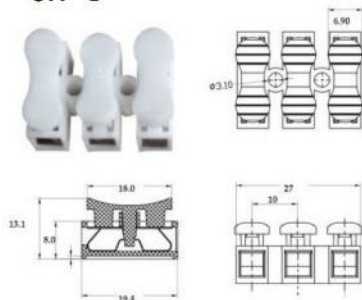

### CB-1



尺寸size: 32.7X9.8X15.7CM

截面Cross section: 进线2.5-6.0mm<sup>2</sup>

出线0.3-1.5mm<sup>2</sup>

颜色Color: 白色white

电流/电压Amp/Volt: 6A/250V

### CB-2



尺寸size: 32.7X22.7X15.7CM

截面Cross section: 进线2.5-6.0mm<sup>2</sup>

出线0.3-1.5mm<sup>2</sup>

颜色Color: 白色white

电流/电压Amp/Volt: 6A/250V

### CB-3



尺寸size: 32.7X32.7X15.7CM

截面Cross section: 进线2.5-6.0mm<sup>2</sup>

出线0.3-1.5mm<sup>2</sup>

颜色Color: 白色white

电流/电压Amp/Volt: 6A/250V

## 接线盒

Junction box with terminal/Luminaire pushwire connector

### TB-1



### TB-2



### TB-3

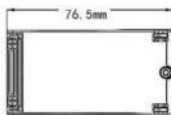

材质Housing:PP

颜色Color:白色White, 黑色Black

# 接线盒

Junction box with terminal/Luminaire pushwire connector



**TB-4**

Material : Polypropylene  
Terminal: 3P, 10A, 450V, 0.5-1.5mm<sup>2</sup>

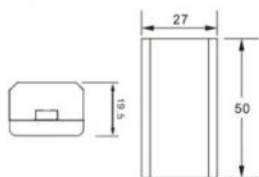

**TB-5**

Material : Polypropylene  
Luminaire pushwire connector:  
3P, 16A, 450V, 0.5-2.5mm<sup>2</sup>  
Terminal:3P, 24A, 450V, 0.5-2.5mm<sup>2</sup>

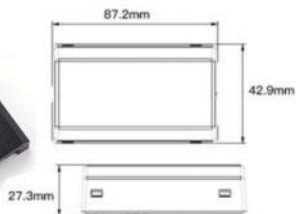

**TB-6**

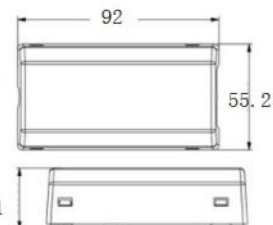

Material : Polypropylene  
Luminaire pushwire connector:  
5P, 16A, 450V, 0.5-2.5mm<sup>2</sup>  
Terminal: 5P, 24A, 450V, 0.5-2.5mm<sup>2</sup>



**TB-7**

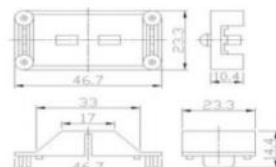

Material : Polypropylene  
Terminal: 2P, 10A, 450V, 0.5-1.5mm<sup>2</sup>



**TB-8**

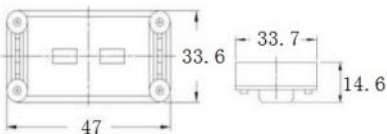
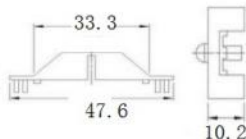

Material : Polypropylene  
Luminaire pushwire connector:  
3P, 16A, 450V, 0.5-2.5mm<sup>2</sup>



**TB-9**

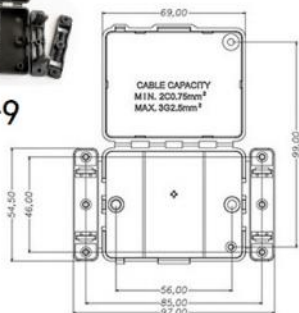

Material : Polypropylene  
Luminaire pushwire connector: 5P, 16A, 450V, 0.5-2.5mm<sup>2</sup>  
Terminal: 5P, 24A, 450V, 0.5-2.5mm<sup>2</sup>

## 接线盒 410

Junction box with terminal/Luminalre pushwire connector



Material : Polypropylene

Luminaire pushwire connector:3P, 16A, 450V, 0.5-2.5mm<sup>2</sup>

Terminal:3P, 24A, 450V, 0.5-2.5mm<sup>2</sup>

## 接线盒 415

Junction box with terminal/Luminalre pushwire connector

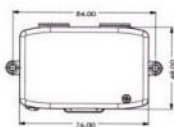

Material : Polypropylene

Luminaire pushwire connector:4P, 16A, 450V, 0.5-2.5mm<sup>2</sup>

Terminal:4P, 24A, 450V, 0.5-2.5mm<sup>2</sup>

## IP44-PA8 waterproof box



SIZE:50.9mmx26mmx21.8mm

·材质housing material:高级尼龙66: Nylon66;

·防火等级fire rating:94V-2 UL94V2,Natural;

孔: ①3.5mm

②5.5mm

## IP44-PA10 waterproof box



孔: 7mm

SIZE:51mmx30mmx20.9mm

·材质housing material:高级尼龙66: Nylon66;

·防火等级fire rating:94V-2 UL94V2,Natural;

## 接线盒 2215

Junction box with terminal/Luminaire pushwire connector

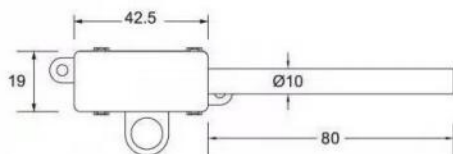
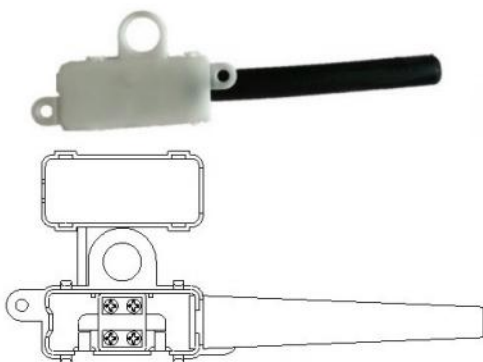

<b>Housing:</b>	94V-2 grade
<b>Solid:</b>	2*1.50mm <sup>2</sup>
<b>Ampere/Voltage:</b>	10A 250VAC
<b>Working:</b>	T100
<b>IP Code:</b>	IP20

## 接线盒 2315

Junction box with terminal/Luminaire pushwire connector

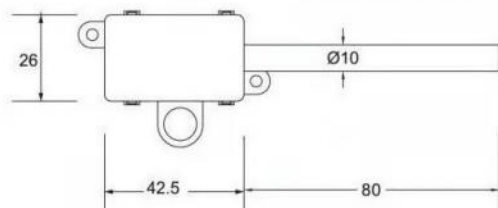
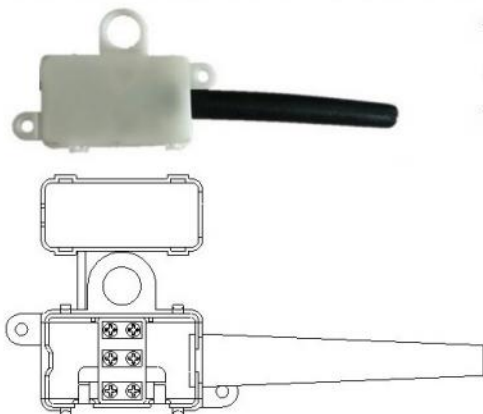

<b>Housing:</b>	94V-2 grade
<b>Solid:</b>	3*1.50mm <sup>2</sup>
<b>Ampere/Voltage:</b>	10A 250VAC
<b>Working:</b>	T100
<b>IP Code:</b>	IP20

## LED灯对插连接器 M16

Luminaire Disconnect

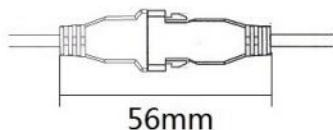
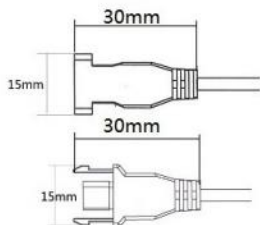

按客户要求定制线缆

Customize wiring to customer requirements

线材材质Wire Material:PVC

外壳材质Housing:ABS

接口类型Interface type:AC/DC

## 带熔断器端子 540

Fused Terminal - Euro-standard



### 规格Technical Data

#### 材料Housing

#### 插入端Insert

薄片Wire protector

螺丝Screw

接地螺丝Earth screw

Voltage / Ampere (IEC)

底座 terminal strip

保险丝 fuse carrier

电压 Voltage / Ampere (UL)

terminal strip

fuse carrier

Temperature

working

short period

Cross section

AWG 电线规格

尼龙 Polyamide 6/6

94V-2级 94V-2 grade

铜, 镀镍 brass, nickel plated

不锈钢 stainless steel

M3x6 黄色 M3x6, yellow chromated

M3x14 黄色 M3x14, yellow chromated

400V / 15A

250V / 6.3A

200V / 15A

200V / 10A

-40°C to 100°C

140°C

2.5mm<sup>2</sup>

14

- 带熔断器 (Terminal strip with fuse-carrier)
- 配合不同的端子组合 (Dovetail for different terminal combinations)
- 5x20mm的保险丝 (For 5x20 mm fuse)
- 合接地螺丝 (Earth-screw option)
- IP 20, finger protection
- 抗震旋转 (Anti-rotation spigot as option)
- 1,2,3,4,5位 (1,2,3,4 and 5 poles available)
- 颜色-底座灰色, 保险丝黑色 (Color-housing in grey, fuse carrier in black)

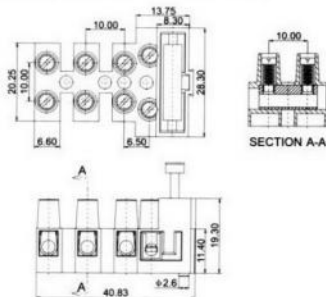

## BS带熔断器端子 FTB8

BS Fused Terminal - screwless wire clamp FTB 8



### 规格Technical Data

#### 材料Housing

#### 插入端Insert

端子螺丝 Terminal screw

接地螺丝 Earth screw

电压电流 Voltage / Ampere

保险丝 Fuse 6 x 25mm

温度 Temperature

使用温度 working

瞬时温度 short time

截面 Cross section

- 熔断器 Screwless wire-clamp terminal with fuse-holder
- 合配件 Rear dovetail for terminal extension
- 适合 For 6 x 25mm 保险丝 For 6 x 25mm fuse
- 带或不带接地螺丝 With or Without earth screw
- 选择安装相应底座/墙角抗震旋转 Choice of mounting base / leg anti-rotation spigot
- 颜色: 白色 Standard color -white

Polycarbonate

94V-2级 94V-2 grade

铜 brass

M3.5 x 7.5 钢镀锌 M3.5 x 7.5 zinc-plated steel

M3.5 x 12 M3.5 x 12 zinc-plated steel

400V / 13A

-20°C to 120°C

160°C

- screw-mount side 0.75 - 2.5mm<sup>2</sup>

- screwless side 0.5 - 1.5mm<sup>2</sup>

## BS带熔断器端子 FTB1

BS Fused Terminal - screwless wire clamp FTB 1



### 规格Technical Data

#### 材料Housing

#### 插入端Insert

端子螺丝 Terminal screw

接地螺丝 Earth screw

电压电流 Voltage / Ampere

保险丝 Fuse 6 x 25mm

温度 Temperature

使用温度 working

瞬时温度 short time

截面 Cross section

Polycarbonate

94V-2级 94V-2 grade

铜 brass

M3.5 x 7.5 钢镀锌 M3.5 x 7.5 zinc-plated steel

M3.5 x 12 M3.5 x 12 zinc-plated steel

400V / 13A

-20°C to 120°C

160°C

- screw-mount side 0.75 - 2.5mm<sup>2</sup>

- screwless side 0.5 - 1.5mm<sup>2</sup>

# 防水压线帽 UnderGround Wire Connector

S1: 22#-12#

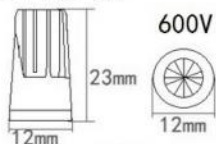

S2: 22#-12#

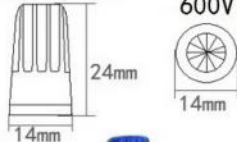

S4: 22#-10#

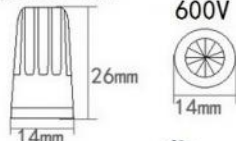

S5: 22#-10#

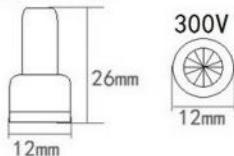

S6: 20#-10#

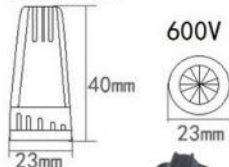

S7: 20#-8#

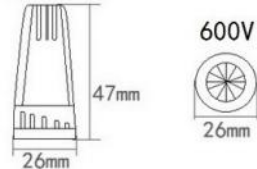

## 概述：

- 1.适用于各种各样的直接埋藏或潮湿位置电气连接。
- 2.本产品适用于园林灌溉和路灯设施以及防水接线要求的设备、阀门、仪表灯适用，产品性能卓越，是胶带和防水胶带的理想替代品。

## Overview：

- 1.Suitable for use in a wide variety of direct burial and wet location electrical connections.
- 2.This product is suitable for garden irrigation and lamp facilities and waterproof wiring request the equipment, valves, instrument light use, product performance excellence is tape and waterproof tape ideal replace product.

胶壳材质Housing:PP

防水材质Waterproof：绝缘密封脂，防水、防潮、防腐蚀  
sealing grease，waterproof、moistureproof、anticorrosion

电压voltage: 300V/600V

环境温度temperature：-40°C to+85°C

## 防雷器 SPD-P02-2 Lightning arrester

IP 20

Compact  
Size

High  
Surge

Special

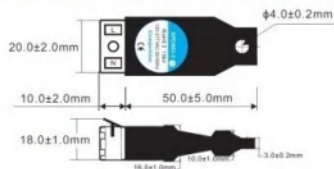

### Product Specification

Product Type	LED Special SPD
Input Voltage	120-277VAC 50/60Hz
Maximum Continuous Voltage	320VAC
Voltage Protection Level(Up)	1300V
Surge Protection Voltage	10kV
Nominal Peak Current(8/20uS)	5kA
Maximum Peak Current(8/20uS)	10kA
Maximum Energy	330 Joules
Standard Leakage Current	<50uA
Response Time	<25nS
Interface Type	863-2 Terminal
Connection Type	Parallel
Protection Class	IP 20
Flame Rating	UL 94-V0/V1
Relative Humidity	<95%(25°C)
Above Sea Level	<3000m
Operating Temperature Range	-40--+85°C
Storage Temperature Range	-40--+125°C
Dimensions	LXTXW=60X16X20mm

### Epcos MOV Panasonic MOV

#### Product Features

- Piece Weight:32g/pcs
- Package:30pcs/box,600pcs/carton
- Common-Mode: None
- L-N In(8/20):5kA,Imax(8/20):10kA
- MLV L-N:<1300V
- Mounting Mode: Fixed
- Designed in IEC61643-11
- Designed in UL1449
- RoHS Compliant

#### Product Applications

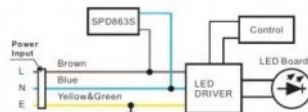

## 防雷器 SPD-P02-3 Lightning arrester

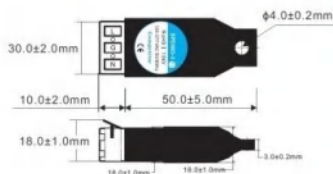

### Product Specification

Product Type	LED Special SPD
Input Voltage	120-277VAC 50/60Hz
Maximum Continuous Voltage	320VAC
Voltage Protection Level(Up)	1300V
Surge Protection Voltage	10kV
Nominal Peak Current(8/20uS)	5kA
Maximum Peak Current(8/20uS)	10kA
Maximum Energy	820 Joules
Standard Leakage Current	<50uA
Response Time	<25nS
Interface Type	863-3 Terminal
Connection Type	Parallel
Protection Class	IP 20
Flame Rating	UL 94-V0/V1
Relative Humidity	<95%(25°C)
Above Sea Level	<3000m
Operating Temperature Range	-40--+85°C
Storage Temperature Range	-40--+125°C
Dimensions	LXTXW=60X16X20mm

### Epcos MOV Panasonic MOV

#### Product Features

- Piece Weight:32g/pcs
- Package:20pcs/box,400pcs/carton
- Common-Mode: Imax(8/20):10kA
- L-N In(8/20):5kA,Imax(8/20):10kA
- MLV L-N:<1300V;L/N-G:<1300V
- Mounting Mode: Fixed
- Designed in IEC61643-11
- Designed in UL1449
- RoHS Compliant

#### Product Applications

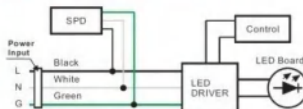

# 防雷器 SPD1

## Lightning arrester

IP 65

Compact  
Size

High  
Surge

Special

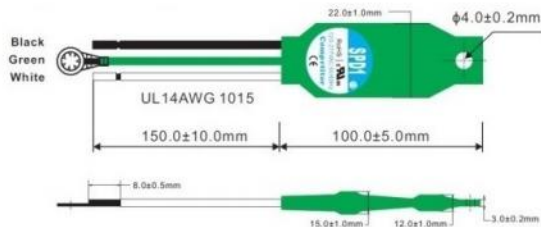

### Product Specification

Product Type	LED Special SPD
Input Voltage	120-277VAC 50/60Hz
Maximum Continuous Voltage	320VAC
Voltage Protection Level(Up)	1300V
Surge Protection Voltage	10kV
Nominal Peak Current(8/20uS)	5kA
Maximum Peak Current(8/20uS)	10kA
Maximum Energy	820 Joules
Standard Leakage Current	<50uA
Response Time	<25nS
Interface Type	3 Wires
Connection Type	Parallel
Protection Class	IP 65
Flame Rating	UL 94V-0/1
Relative Humidity	<95%(25°C)
Above Sea Level	<3000m
Operating Temperature Range	-40--+85°C
Storage Temperature Range	-40--+125°C
Dimensions	LXTXW=250X15X22mm

### Epcos MOV Panasonic MOV

#### Product Features

- Piece Weight:50g/pcs
- Package:20pcs/box,400pcs/carton
- L/N-G In(8/20):5kA,Imax(8/20):10kA
- L-N In(8/20):5kA,Imax(8/20):10kA
- MLV L-N:1150V;L-G:1260V;N-G:1270V
- Mounting Mode: Fixed
- Designed in IEC61643-11
- Designed in UL1449
- RoHS Compliant

#### Product Applications

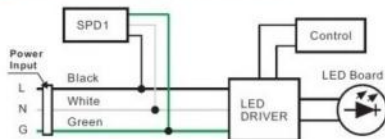

## 雙翼彈簧螺式接頭

### Screw On Wire Connector



- 材質構造：採PP料制成，絕緣性良好，內附彈簧，適用於單蕊及較粗蕊之電線可耐至105°C。
- 特點：外型設有扭轉翼，使操作省力輕便，易于將電線固定。  
Material: Tough thermoplastic, UL 94V-2 flame-retardant shell. Two wing makes move easy twist on termination of wires. Strip wires before application.  
Rated at 600 volt max. for building wiring.



型號 Item No.	內徑 B	寬 C	高 E	適用電線範圍 Wires Combination	顏色 Color	包裝 Packing
P11	9.8	18.2	25.8	Max 3#12 Min 2#18	黃色 yellow	100 pcs
P13	13.5	23	31.8	Max 5#12 Min 3#16	紅色 red	
P15	14.9	25.5	33.3	Max 3#10 Min 3#14 w/1 #18	灰色 gray	
P17	18.8	32	40	Max 3#18 w/1 #12 Min 2#10 w/1 #12	藍色 blue	

## 彈簧螺式接線頭

### SCREW-ON CONNECTOR



- 電壓：300V/600V
- 溫度：105°C
- 材質：高級PVC塑膠原料，絕緣佳。
- 國際認證：通過美國UL，加拿大CSA安全測試。
- 用途：適用於各種電器產品，家庭配線等接線器材，耐用且絕緣性佳，安全可靠。

Voltage: 300V/600V  
Temperature: 105°C  
Material: PVC  
International Certification: UL CSA  
Use used in all kinds of electrical products home wiring and other wiring devices. durability and good insulation safe and reliable.

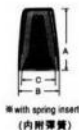

※ with spring insert  
(內附彈簧)

型號 Item No.	顏色 Color	高 A mm	寬 B mm	螺紋內徑 C mm	適用電線範圍 Suitable Wires A.W.G.	包裝 (每包) Pack/bag
P1	Orange	15.2	8.8	6.7	22-14	1000 PCS.
P2	Orange	17.6	9.8	7.4	22-14	
P3	Orange	22.0	12	9.9	22-14	
P4	Orange	24.5	14	11	22-10	500 PCS.
P6	Red	26.5	16.4	13	22-8	

## 閉端端子

### CLOSE-END CONNECTOR

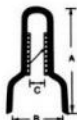

型號 Item No.	高 A mm	寬 B mm	金屬內徑 C mm	適用電線範圍 Suitable Wires		適用工具 Suitable Crimping Tools	包裝 (每包) Pack/bag
				平方線mm <sup>2</sup>	A.W.G.		
CE1	18	6.2	2.6	1.25	22-18	1000 PCS.	
CE2	19.7	7.9	3	2	22-14		
CE5	25.5	10.5	4	5.5	22-10		
CE8	27.7	12.4	5.3	8	16-10		

\*電壓：300V. (Voltage : 300V)

\*溫度：94V-2 105°C (Temperature : 105°C)

\*材質 Material：高級尼龍66工程塑膠原料，防火等級94V-2，94V-0 150°C(Temperature)，絕緣佳不易老化。

\*使用工具 Tool：氣動工具MR-30A，IZUMI AC-5ND，手動工具AK-25，AK-28，IZUMI #7A。

\*國際認證 Certification：通過美國UL，加拿大CSA安全測試。

\*用途 Usage：使用於各種電器產品，燈飾，家庭配線等接線器材。 Used in all kinds of electrical products home wiring and other wiring devices.

# 電源線扣

## STRAIN RELIEF BUSHINGS

### 裝配方式(Assembly Procedure)

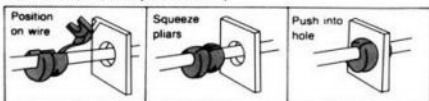

- 1.將電源線放置線扣內。 2.將線扣結合夾緊 3.利用線扣工具夾緊塞入機板出線孔，即可固定電源線



Maximum Chassis thickness-Part actually has additional clearance (適用機板厚度)

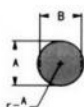

MOUNTING HOLE. (機板孔徑)



H. NO.1  
Assembly Tool (線扣工具)

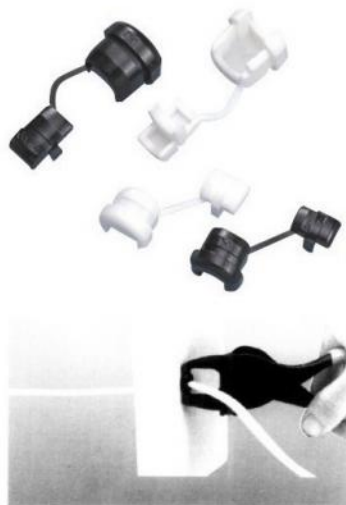

型號 Item No.	型狀 Cross Section Shape	適用UL電線 UL Wires Accommodated	適用電線尺寸 Approx. Wire Size mm	機板孔口徑 Mounting Holes		適用機板厚度 Max. Thickness F mm	線扣長度 Length D mm	包裝 (每包) Pack/bag
				A mm	B mm			
2P-4	Flat (扁線用)	SPT-1	3 × 5.6	9.5	8.7	1.6	10.3	1000 PCS.
3P-4		SPT-1	3 × 5.6	11	9.9	1.6	10.3	
3W-1		SPT-1	3 × 5.6	11	9.9	2.5	10.3	
4N-4		SPT-2	3.71 3.8 × 7.6	12.7-13.1	11.8	1.6	10.3	
4K-4		SPT-2	3.71 3.8 × 7.6	12.7-13.1	11.8	2.5	10.3	
5N-4	Round (圓線用)	SVI SVT	6.4φ - 7.4φ	12.7-13.1	11.5	1.6	11	500 PCS.
5P-4		SVI SVT	6.4φ - 7.4φ	12.7-13.1	11.5	2.5	11	
6N-4		SJT 3C #18	7.6φ	15.9	14	1.6	14.8	
6P-4		SJT 3C #18	7.6φ	15.9	14	3.2	14.8	
6N3-4		SJT 3C #16	8.2φ - 9.2φ	15.9	14	1.6	14.8	
6P3-4		SJT 3C #16	8.2φ - 9.2φ	15.9	14	3.2	14.8	
7N-2		SJT 3C #14	9.2φ - 10.5φ 11φ	19 19.8	16.8	1.6	19	
7P-2		SJT 3C #14	9.2φ - 10.5φ	19	16.8	3.2	19	
			11φ	19.8				
								100 PCS.

\*材質：高級尼龍66工程塑膠，防火等級94V-2，絕緣性佳，耐久不易老化。

\*國際認證：通過美國UL，加拿大CSA安全測試。

\*用途：使用於各種電器產品，燈飾等電線出口之固定與保護。

1. Material: nylon66, 94v-2, good insulation.

2. International Certification: UL CSA.

3. Use: protect the wires.

# 扣式護線套

## SNAP BUSHINGS

扣式護線套



型號 Item No.	外徑 (機板口徑) Mounting Hole Diameter D mm	覆蓋 Head Diameter B mm	內徑 Inside Diameter A mm	高度 Overall Height C mm	包裝 (每包) Pack/bag
312-3	8	9.6	5.2	8.3	1000 PCS.
375-4	9.5	12	6.4	10.3	
0811	11.1	13.6	8.2	10.3	
0813	13	15.1	9.8	10.3	
1216	16	18.1	12.9	10.3	

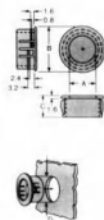

- \*材質：高級尼龍66工程塑膠，防火等級94V-2，絕緣性佳，耐久不易老化。
  - \*國際認證：通過美國UL，加拿大CSA安全測試。
  - \*用途：一般電源線出線之固定均可使用，兼具絕緣與保護電源線之功能。
- Material: nylon66,94v-2,good insulation.  
International Certification:UL CSA.  
Use:To fix and protect the wires.

# 開口型扣式護線套

## OPEN/CLOSED BUSHINGS

開口型扣式護線套



型號 Item No.	外徑 (機板口徑) Mounting Hole Diameter D mm	覆蓋 Head Diameter B mm	內徑 Inside Diameter A mm	高度 Overall Height C mm	包裝 (每包) Pack/bag
0813C	12.5-13	14.6	9	10.1	1000 PCS.
1216C	15.5-16	17.8	12	10.5	
1419C	18-19	21	14.4	11	

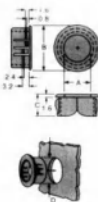

- \*材質：高級尼龍66工程塑膠，防火等級94V-2，絕緣性佳，耐久不易老化。
  - \*用途：電源供應器，控制箱或一般電源線出線之固定均可使用，兼具絕緣與保護電源線之功能。
- Material: nylon66,94v-2,good insulation.  
International Certification:UL CSA.  
Use:To fix and protect the wires.

# R型线夹Clamp

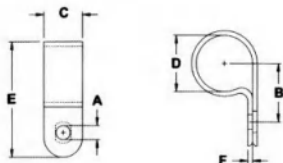

型號 Item No.	螺絲孔 A	B	C	束線徑 D	E	F	包裝 Packing
UC-0	4.8	8	9.6	3.1 (1/8") 1分	17	1.2	100pcs
UC-0.5	4.8	9.2	9.6	5.0 (3/16") 2分	18.6	1.2	
UC-1	4.6	10.0	10.0	6.35 (1/4") 2分	20.0	1.4	
UC-1.5	4.6	12.0	10.0	7.9 (5/16") 2分	22.0	1.5	
UC-2	4.6	12.5	12.0	9.5 (3/8") 3分	24.0	1.5	
UC-3	5.0	15.2	12.0	12.7 (1/2") 4分	31.0	1.5	
UC-4	4.6	18.2	12.0	15.8 (5/8") 5分	34.3	1.5	
UC-5	4.6	18.2	11.78	19.4 (3/4") 6分	35.0	1.5	
UC-6	4.6	22.0	12.0	25.4 (1") 1吋	43.0	1.8	
UC-6.5	4.6	24.0	12.0	27.5 (1 1/16")	50.0	1.8	
UC-7	4.6	26.2	12.0	31.8 (1 1/4") 1吋2分	46.2	1.8	
UC-9	4.6	30.0	12.0	36.7 (1 1/2") 1吋3分	50.0	1.8	

- 材 質：UL合格之NYLON 66 (本色)，防火等級 94V-2。  
 使用方法：將電纜套入鉤環中(如附圖)，再以螺絲固定。  
 用 途：電機、電子、冷氣配線之固定用。  
 Material: nylon66,94v-2.  
 How to use:through the wire to the hole,the fixed with screw  
 Use:to and protect the wires.

# 拨动开关Slide Switch

型号Model No. : 3-MS23-4-1-1-G7

额定Rating: 6(2)A 3(2)A 250V/125VAC

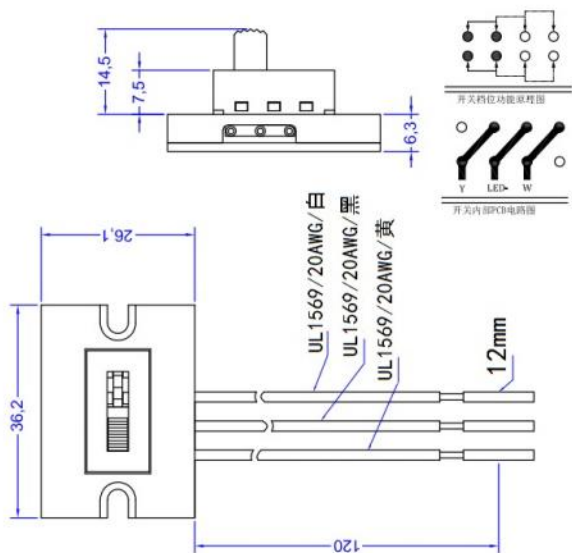

型号Model No. : MS922

额定Rating: 0.3A 50VDC 0.6A 60VDC



尺寸Size: 38\*14\*22mm

型号Model No. : MS923

额定Rating: 0.3A 50VDC 0.6A 60VDC



尺寸Size: 38\*14\*15mm

# 插头插座系列PLUGS&RECEPTACLE

## MS-23

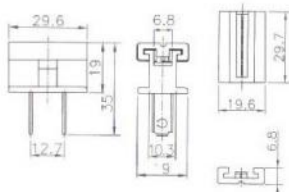

額定: 8A 125V Rating: 8A 125V  
 材質: 塑膠 Material: Plastic Base  
 電線: SPT-2 Wire: SPT-2

## MS-33

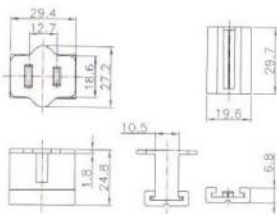

額定: 6A 125V Rating: 6A 125V  
 材質: 塑膠 Material: Plastic Base  
 電線: SPT-2 Wire: SPT-2

## MS-05

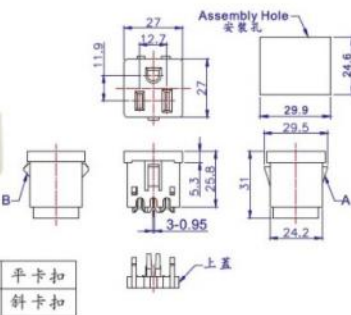

額定: 13A 125V Rating: 13A 125V  
 材料: 塑膠 Material: Plastic Base  
 適用: 16AWG单芯线 Suitable for: 16AWG Solid

## MS-06

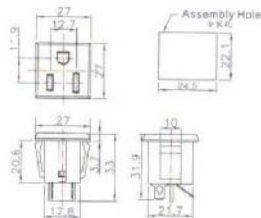

額定: 15A 125V 14AWG Rating: 15A 125V 14AWG  
 10A 125V 16~18AWG 10A 125V 16~18AWG  
 材質: 塑膠 Material: Plastic Base

## 綫扣系列





# 信亿电子科技有限公司

Sineyi Electronic Technology Co.,Ltd

工厂地址：浙江省余姚市高阪路2号

Street Address:NO.2 Gaofan road Yuyao Zhejiang China

电话 (Tel) : ( 86 ) 574-62681408 62681409 62523002 传真 (Fax) : ( 86 ) 574-62681407

广东分公司：电话/传真：0752-3543609，手机13829999990/13335846234

地址Add：广东省惠州市惠城区陈江新华大道

Chen Jiang Xinhua Avenue, Huicheng District, Huizhou City, Guangdong Province

全国服务热线：13335846234 13175193908

<http://www.sineyi.com>

<http://www.sineyi.en.alibaba.com>

E-mail : [sineyi@sineyi.com](mailto:sineyi@sineyi.com)



Группа компаний SETCO

официальный Представитель Sineyi Electronic Technology Co., Ltd.

в России, Беларуси и Казахстане

Тел: +7 495 2490584

E-mail: [sales@setco-group.ru](mailto:sales@setco-group.ru)

[www.lightcomponents.ru](http://www.lightcomponents.ru)