



■ Features :

- Compliance to EN50155 and EN45545-2 railway standard
- 2:1 wide input range
- Protections: Short circuit / Overload / Over voltage / Input reverse polarity
- 4000VDC I/O isolation
- Cooling by free air convection
- Half encapsulated
- Built-in constant current limiting circuit
- 1U low profile 36mm
- All using 105°C long life electrolytic capacitors
- LED indicator for power on
- 100% full load burn-in test
- 3 years warranty



SPECIFICATION

| MODEL | | RSD-100B-5 | RSD-100B-12 | RSD-100B-24 | RSD-100C-5 | RSD-100C-12 | RSD-100C-24 | RSD-100D-5 | RSD-100D-12 | RSD-100D-24 | |
|-----------------------|--|---|----------------|----------------|------------|----------------|--------------|------------|---------------|--------------|--|
| OUTPUT | DC VOLTAGE | 5V | 12V | 24V | 5V | 12V | 24V | 5V | 12V | 24V | |
| | RATED CURRENT | 20A | 8.4A | 4.2A | 20A | 8.4A | 4.2A | 20A | 8.4A | 4.2A | |
| | CURRENT RANGE | 0 ~ 20A | 0 ~ 8.4A | 0 ~ 4.2A | 0 ~ 20A | 0 ~ 8.4A | 0 ~ 4.2A | 0 ~ 20A | 0 ~ 8.4A | 0 ~ 4.2A | |
| | RATED POWER | 100W | 100.8W | 100.8W | 100W | 100.8W | 100.8W | 100W | 100.8W | 100.8W | |
| | RIPPLE & NOISE (max.) Note.2 | 100mVp-p | 120mVp-p | 150mVp-p | 100mVp-p | 120mVp-p | 150mVp-p | 100mVp-p | 120mVp-p | 150mVp-p | |
| | VOLTAGE TOLERANCE Note.3 | ± 2.0% | ± 2.0% | ± 2.0% | ± 2.0% | ± 2.0% | ± 2.0% | ± 2.0% | ± 2.0% | ± 2.0% | |
| | LINE REGULATION | ± 0.5% | ± 0.3% | ± 0.2% | ± 0.5% | ± 0.3% | ± 0.2% | ± 0.5% | ± 0.2% | ± 0.2% | |
| | LOAD REGULATION | ± 1.0% | ± 1.0% | ± 1.0% | ± 1.0% | ± 1.0% | ± 1.0% | ± 1.0% | ± 1.0% | ± 1.0% | |
| | SETUP, RISE TIME | 800ms, 50ms at full load | | | | | | | | | |
| HOLD UP TIME (Typ.) | B/C- type comply with S1 level @ full load, comply with S2 level @ 70% load ; D-type comply with S2 level @ full load | | | | | | | | | | |
| INPUT | VOLTAGE RANGE | CONTINUOUS | 16.8 ~ 31.2VDC | | | 33.6 ~ 62.4VDC | | | 67.2 ~ 143VDC | | |
| | | 1 SEC. | 14.4 ~ 33.6VDC | | | 28.8 ~ 67.2VDC | | | 57.6 ~ 154VDC | | |
| | EFFICIENCY (Typ.) | 88% | 89% | 89% | 89% | 91% | 91% | 89.5% | 91% | 90% | |
| | DC CURRENT (Typ.) | 4.8A/24V | 4.8A/24V | 4.8A/24V | 2.4A/48V | 2.4A/48V | 2.4A/48V | 1.2A/110V | 1.2A/110V | 1.2A/110V | |
| INRUSH CURRENT (Typ.) | 30A/24VDC | | | 30A/48VDC | | | 30A/110VDC | | | | |
| PROTECTION | OVERLOAD | 105 ~ 135% rated output power Protection type : Constant current limiting, recovers automatically after fault condition is removed | | | | | | | | | |
| | OVER VOLTAGE | 5.75 ~ 7V | 13.8 ~ 16.2V | 27.6 ~ 32.4V | 5.75 ~ 7V | 13.8 ~ 16.2V | 27.6 ~ 32.4V | 5.75 ~ 7V | 13.8 ~ 16.2V | 27.6 ~ 32.4V | |
| ENVIRONMENT | WORKING TEMP. | -40 ~ +55°C (no derating) ; +70°C @ 60% load by free air convection ; +70°C no derating with external base plate, TX class compliance | | | | | | | | | |
| | WORKING HUMIDITY | 5 ~ 95% RH non-condensing | | | | | | | | | |
| | STORAGE TEMP., HUMIDITY | -40 ~ +85°C , 5 ~ 95% RH non-condensing | | | | | | | | | |
| | TEMP. COEFFICIENT | ± 0.03%/°C (0 ~ 50°C) | | | | | | | | | |
| | VIBRATION | 10 ~ 500Hz, 5G 10min./1cycle, 60min. each along X, Y, Z axes ; Mounting : compliance to IEC61373 | | | | | | | | | |
| SAFETY & EMC (Note 5) | SAFETY STANDARDS | IEC60950-1(LVD), EAC TP TC 004 approved | | | | | | | | | |
| | WITHSTAND VOLTAGE | I/P-O/P:4KVDC | | I/P-FG:2.5KVDC | | O/P-FG:2.5KVDC | | | | | |
| | ISOLATION RESISTANCE | I/P-O/P, I/P-FG, O/P-FG:100M Ohms / 500VDC / 25°C / 70% RH | | | | | | | | | |
| | EMC EMISSION | Compliance to EN55032 (CISPR32) Conduction Emission: Class A, Radiation Emission: Class B, EAC TP TC 020 | | | | | | | | | |
| | EMC IMMUNITY | Compliance to EN61000-4-2,3,4,5,6,8, light industry level, criteria A, EAC TP TC 020 | | | | | | | | | |
| OTHERS | RAILWAY STANDARD | EN50155 / IEC60571 including IEC61373 for shock & vibration, EN50121-3-2 for EMC ; EN45545-2 for fire protection | | | | | | | | | |
| | MTBF | 254.1K hrs min. MIL-HDBK-217F (25°C) | | | | | | | | | |
| | DIMENSION | 161*68*36mm (L*W*H) | | | | | | | | | |
| | PACKING | 0.6Kg; 24pcs/15.4Kg/0.98CUFT | | | | | | | | | |
| NOTE | <ol style="list-style-type: none"> 1. All parameters NOT specially mentioned are measured at 24,48,110VDC input, rated load and 25°C of ambient temperature. 2. Ripple & noise are measured at 20MHz of bandwidth by using a 12" twisted pair-wire terminated with a 0.1uf & 47uf parallel capacitor. 3. Tolerance : includes set up tolerance, line regulation and load regulation. 4. Strongly recommended that external output capacitance should not exceed 5000uF. (Only for: RSD-100-5 / -12) 5. The power supply is considered a component which will be installed into a final equipment. All the EMC tests are been executed by mounting the unit on a 360mm*360mm metal plate with 1mm of thickness. The final equipment must be re-confirmed that it still meets EMC directives. For guidance on how to perform these EMC tests, please refer to "EMI testing of component power supplies." (as available on http://www.meanwell.com) 6. The ambient temperature derating of 3.5°C/1000m with fanless models and of 5°C/1000m with fan models for operating altitude higher than 2000m(6500ft). | | | | | | | | | | |

Mechanical Specification

Case No.999A Unit:mm

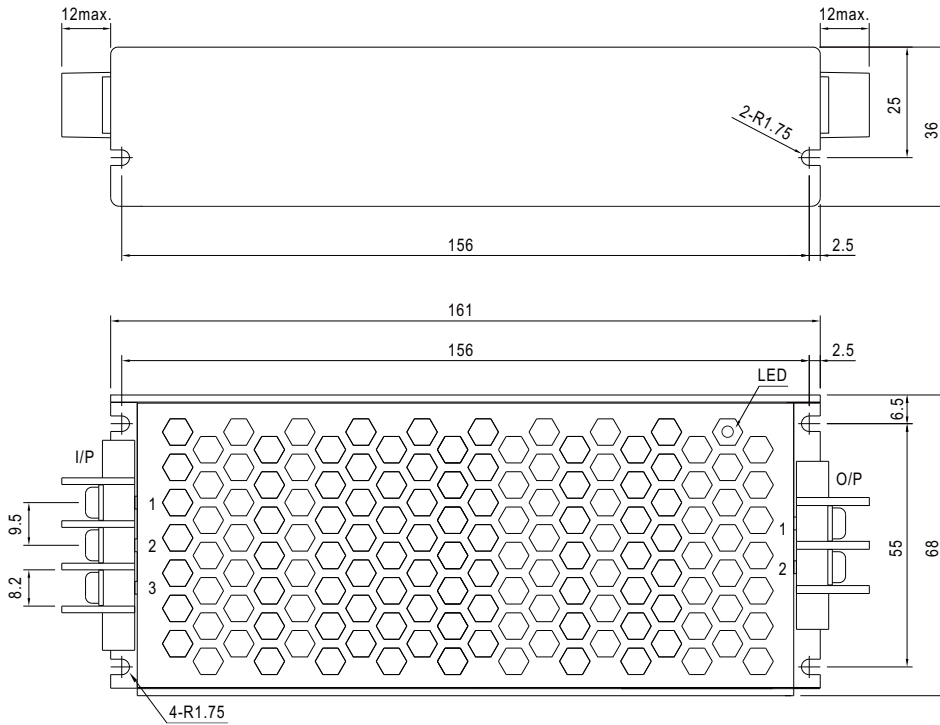

Input Terminal Pin No. Assignment :

| Pin No. | Assignment |
|---------|-------------|
| 1 | DC INPUT V+ |
| 2 | DC INPUT V- |
| 3 | FG \perp |

Output Terminal Pin No. Assignment :

| Pin No. | Assignment |
|---------|--------------|
| 1 | DC OUTPUT -V |
| 2 | DC OUTPUT +V |

Block Diagram

fosc : 130KHz

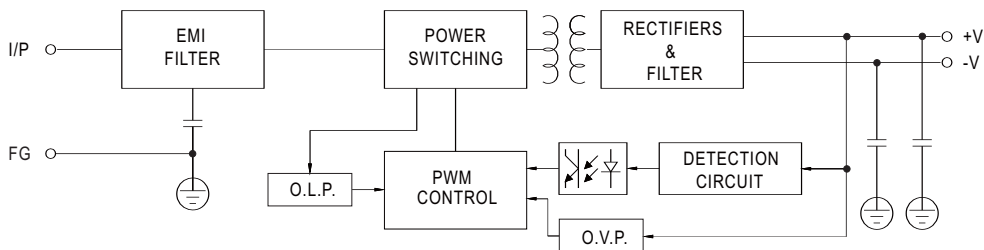

Input Fuse

There is one fuse connected in series to the positive input line, which is used to protect against abnormal surge. Fuse specifications of each model are shown as below.

| Type | Fuse Type | Reference and Rating |
|------|-----------|----------------------------|
| B | Time-Lag | Conquer UDA-A, 10A, 250V |
| C | Time-Lag | Conquer UDA-A, 5A, 250V |
| D | Time-Lag | Conquer UDA-A, 3.15A, 250V |

Input Reverse Polarity Protection

There is a MOSFET connected in series to the negative input line. If the input polarity is connected reversely, the MOSFET opens and there will be no output to protect the unit.

Input Range and Transient Ability

The series has a wide range input capability. Within $\pm 30\%$ of rated input voltage, it can be executed at full-load operation and operate properly; with $\pm 40\%$ of rated input voltage, it can withstand that for 1 second.

Input Under-Voltage Protection

If input voltage drops below V_{imin} , the internal control IC shuts down and there is no output voltage. It recovers automatically when input voltage reaches above V_{imin} , please refer to the cruve below.

RSD-100B-24

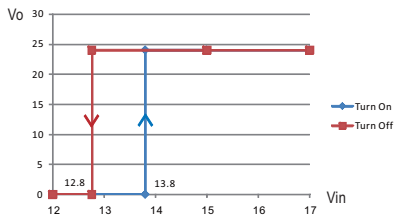

RSD-100C-24

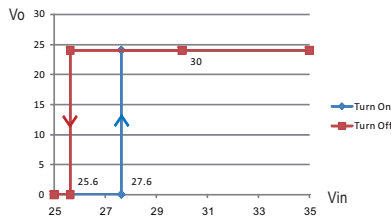

RSD-100D-24

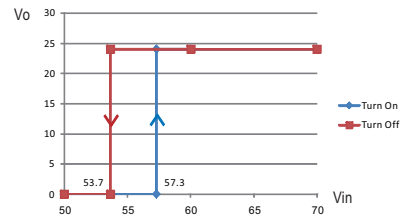

Inrush Current

Inrush current is suppressed by a resistor during the initial start-up, and then the resistor is bypassed by a MOSFET to reduce power consumption after accomplishing the start-up.

Hold-up Time

D type is in compliance with S2 level, while B and C types are in compliance with S1 level at full load output condition. To fulfil the requirements of S2 level, B and C types require de-rating their output load to 70%, please refer to the curve diagrams below.

RSD-100B-5

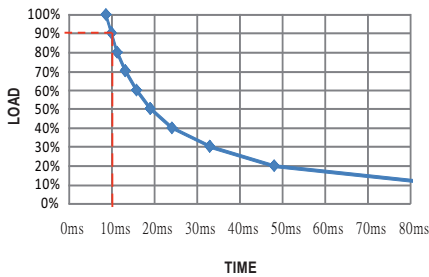

RSD-100B-12

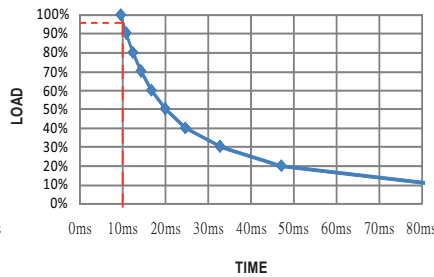

RSD-100B-24

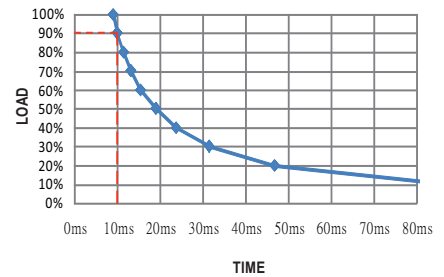

RSD-100C-5

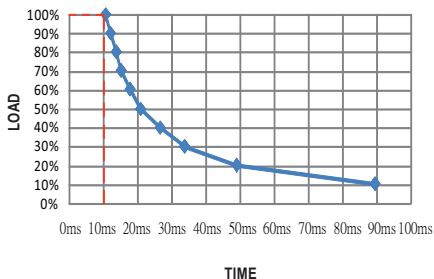

RSD-100C-12

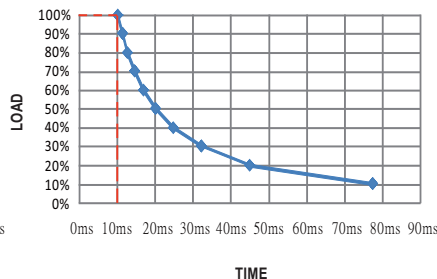

RSD-100C-24

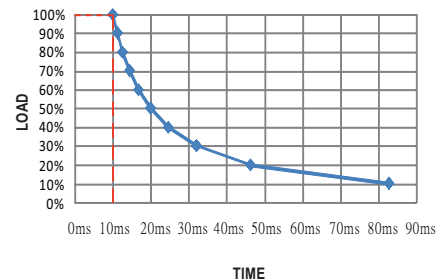

Output Voltage Adjustment

This function is optional, which the standard product does not have it. If you do need the function, please contact MW for details.

Efficiency vs Load & Vin Curve

The efficiency vs load & Vin curves of each model are shown as below.

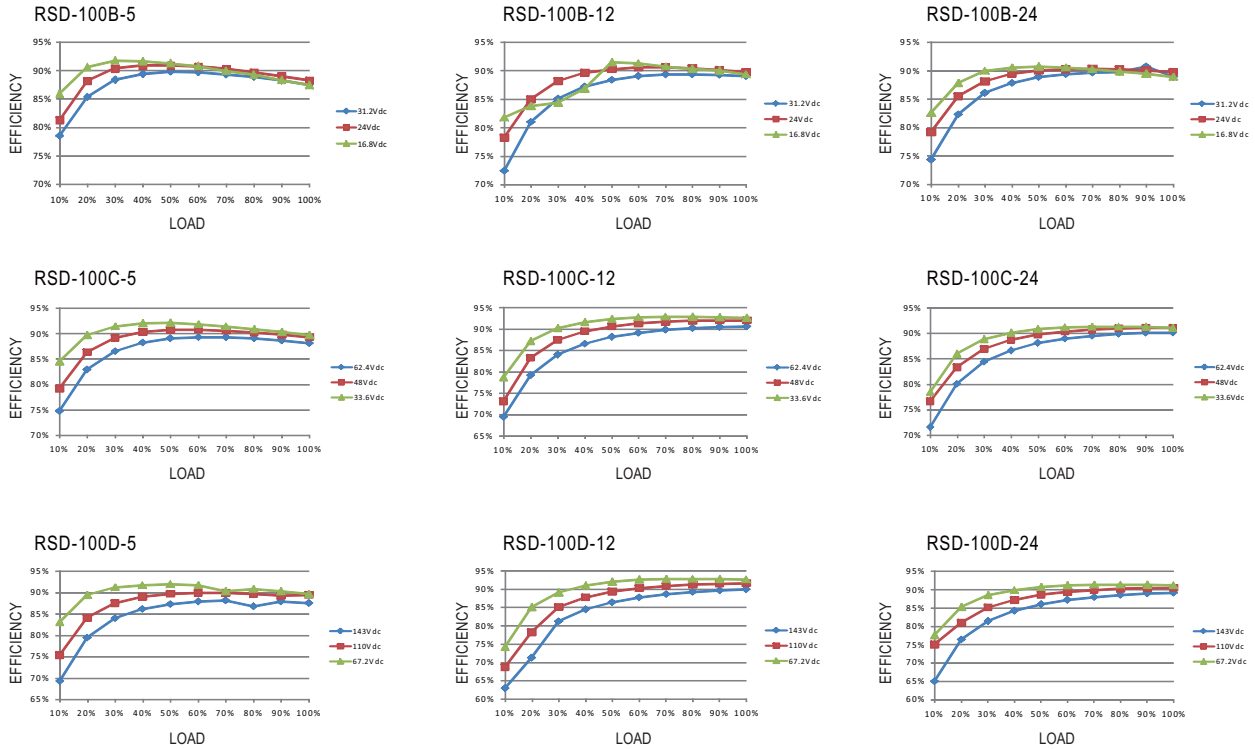

Parallel and Series Connection

A. Operation in Parallel

Since RSD-100 series don't have built-in parallel circuit, it can only use external circuits to achieve the redundant operation but not increase the current rating.

1. Add a diode at the positive-output of each power supply (as shown as below), the current rating of the diode should be larger than the maximum output current rating and attached to a suitable heat sink. This is only for redundant use (increase the reliability of the system) and users have to check suitability of the circuit by themselves.



2. When using S.P.S. in parallel connection, the leakage current will increase at the same time. This could pose as a shock hazard for the user. So please contact the supplier if you have this kind of application.

B. Operation in Series

RSD-100 can be operated in series. Here are the methods of doing it:

1. Positive and negative terminals are connected as shown as below. According to the connection, you can get the positive and negative output voltages for your loads.

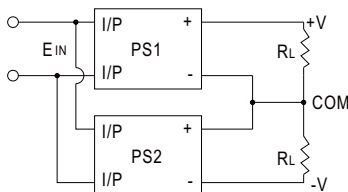

2. Increase the output voltage (current does not change). Because RSD-100 series have no reverse blocking diode in the unit, you should add an external blocking diode to prevent the damage of every unit while starting up. The voltage rating of the external diode should be larger than $V1+V2$ (as shown as below).

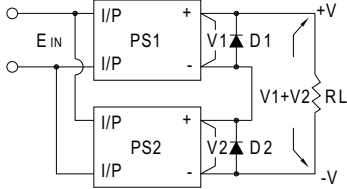

Overload Protection

If the output draw up to 105~135% of its output power rating, the converter will go into overload protection which is constant current mode. After the faulty condition is removed, it will recover automatically. Please refer to the diagram below for the detail operation characteristic. Please note that it's not suitable to operate within the overload region continuously, or it may cause to over temperature and reduce the life of the power supply unit or even damage it.

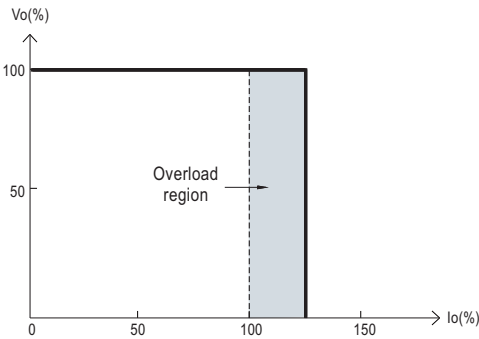

Over Voltage Protection

The converter shuts off to protect itself when the output voltage drawn exceeds 115~140% of its output rating. It must be repowered on to recover.

LED Indicator

Equipped with a built-in LED indicator, the converter provides an easy way for users to check its condition through the LED indicator.
Green : normal operation; No signal: no power or failure.

Derating Curve

a. Single unit operation

If the unit has no iron plate mounted on its bottom, the maximum ambient temperature for the unit will be 55°C as operating under full load condition. It requires de-rating output current when ambient temperature is between 55-70°C, please refer to the de-rating curve as below.

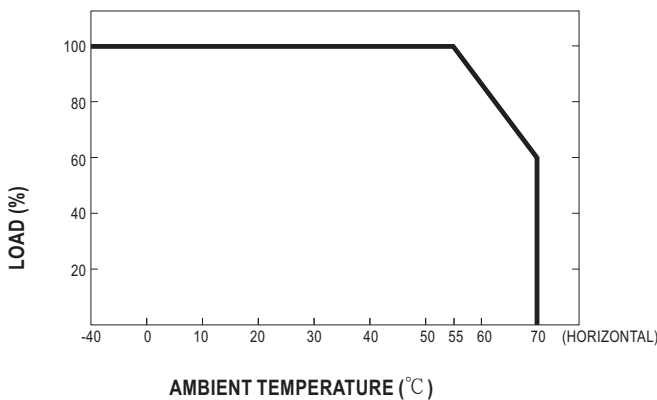

Suitable installation methods are shown as below. Since RSD-100 is a semi-potted model, its thermal performances for the following installation methods are similar and share the same derating curve.

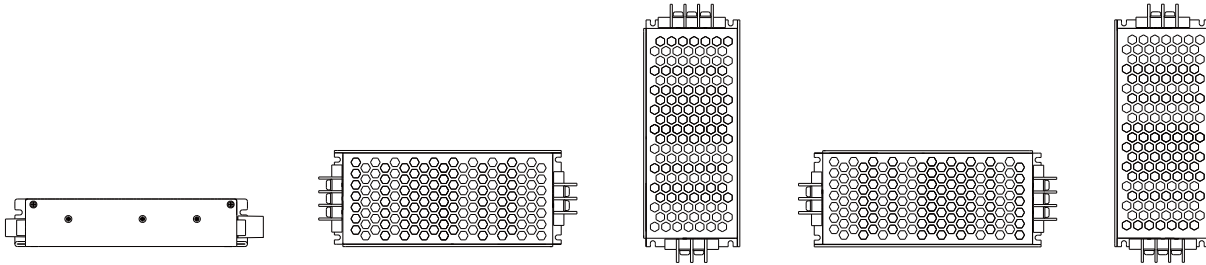

b. Operate with additional iron plate

If it is necessary to fulfil the requirements of EN50155 TX level that operate the unit fully-loaded at 70°C, RSD-100 series must be installed onto an iron plate on the bottom. The size of the suggested iron plate is shown as below. In order for optimal thermal performance, the iron plate must have an even & smooth surface and RSD-100 series must be firmly mounted at the center of the iron plate.

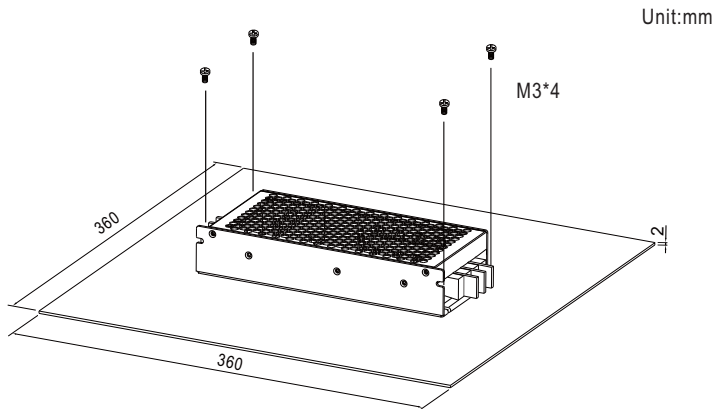

The load vs ambient temperature curve is shown as below.

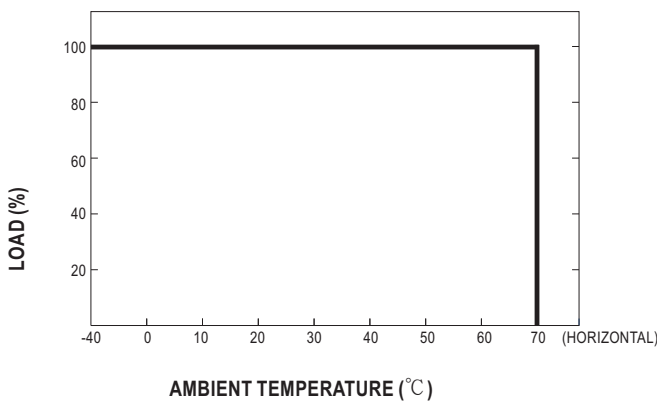

Suitable installation methods are shown as below. Since RSD-100 is a semi-potted model, its thermal performances for the following installation methods are similar and share the same derating curve.

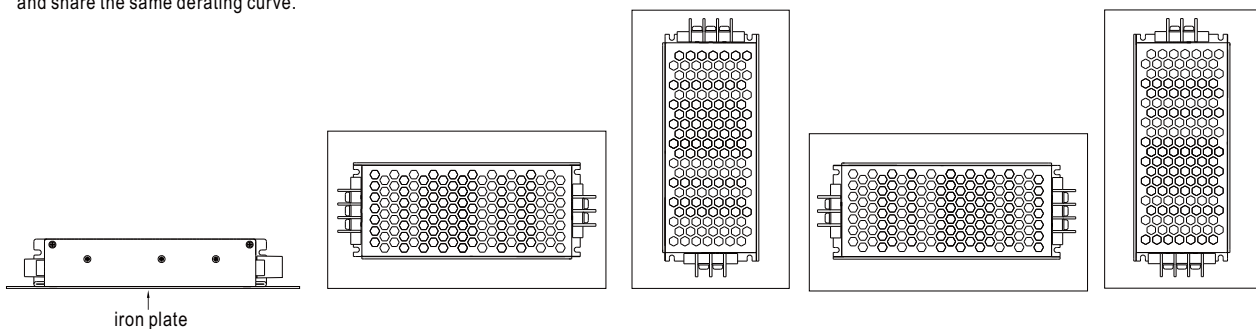

■ Immunity to Environmental Conditions

| Test method | Standard | Test conditions | Status |
|------------------------------|---|---|-----------|
| Cooling Test | EN 50155 section 12.2.3 (Column 2, Class TX) EN 60068-2-1 | Temperature: -40°C Dwell Time: 2 hrs/cycle | No damage |
| Dry Heat Test | EN 50155 section 12.2.4 (Column 2, Class TX) EN 50155 section 12.2.4 (Column 3, Class TX & Column 4, Class TX) EN 60068-2-2 | Temperature: 70°C / 85°C Duration: 6 hrs / 10min | PASS |
| Damp Heat Test, Cyclic | EN 50155 section 12.2.5 EN 60068-2-30 | Temperature: 25°C~55°C Humidity: 90%~100% RH Duration: 48 hrs | PASS |
| Vibration Test | EN 50155 section 12.2.11 EN 61373 | Temperature: 19°C Humidity: 65% Duration: 10 mins | PASS |
| Increased Vibration Test | EN 50155 section 12.2.11 EN 61373 | Temperature: 19°C Humidity: 65% Duration: 5 hrs | PASS |
| Shock Test | EN 50155 section 12.2.11 EN 61373 | Temperature: 21 ± 3°C Humidity: 65 ± 5% Duration: 30ms*18 | PASS |
| Low Temperature Storage Test | EN 50155 section 12.2.3 (Column 2, Class TX) EN 60068-2-1 | Temperature: -40°C Dwell Time: 16 hrs | PASS |
| Salt Mist Test | EN 50155 section 12.2.10 (Class ST4) | Temperature: 35°C ± 2°C Duration: 96 hrs | PASS |

■ EN45545-2 Fire Test Conditions

| Test Items | | | Hazard Level | | |
|------------|---------------------|---------------------------------------|--------------|------|------|
| | Items | Standard | HL1 | HL2 | HL3 |
| R22 | Oxygen index test | EN 45545-2:2013 EN ISO 4589-2:1996 | PASS | PASS | PASS |
| | Smoke density test | EN 45545-2:2013 EN ISO 5659-2:2006 | PASS | PASS | PASS |
| | Smoke toxicity test | EN 45545-2:2013 NF X70-100:2006 | PASS | PASS | PASS |
| R24 | Oxygen index test | EN 45545-2:2013 EN ISO 4589-2:1996 | PASS | PASS | PASS |
| R25 | Glow-wire test | EN 45545-2:2013 EN 60695-2-11:2000 | PASS | PASS | PASS |
| R26 | Vertical flame test | EN 45545-2:2013 EN 60695-11:2003 | PASS | PASS | PASS |