

BLA-121

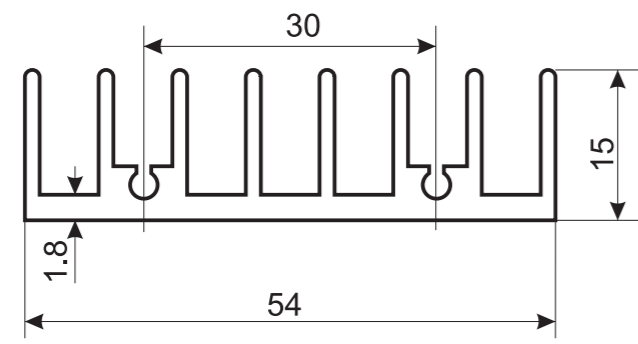

BLA-122

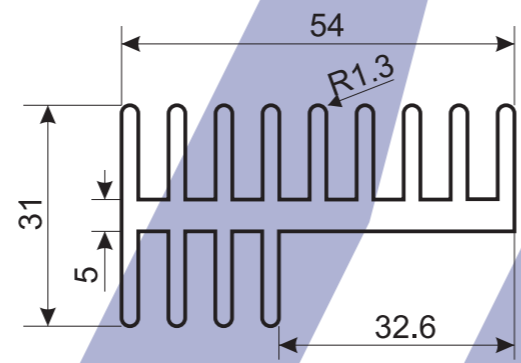

BLA-123

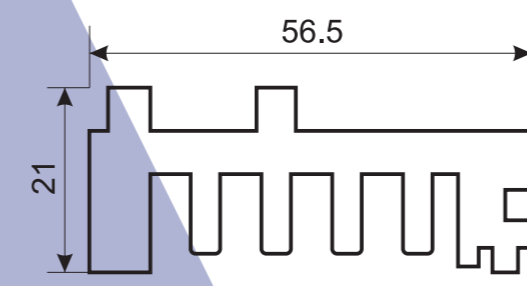

BLA-124

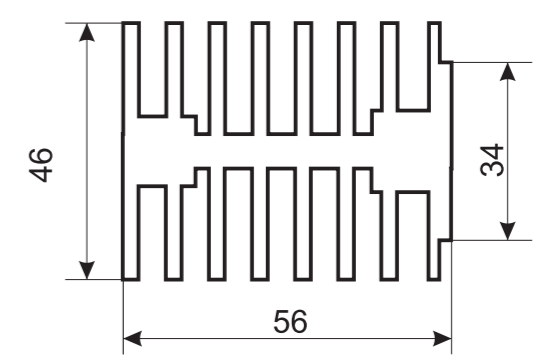

BLA-125

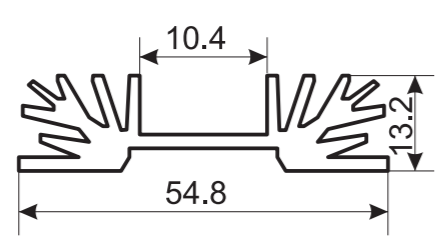

BLA-126

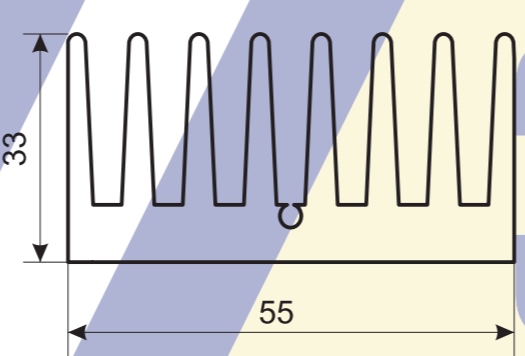

BLA-127

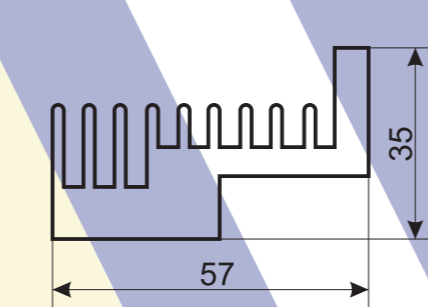

BLA-128

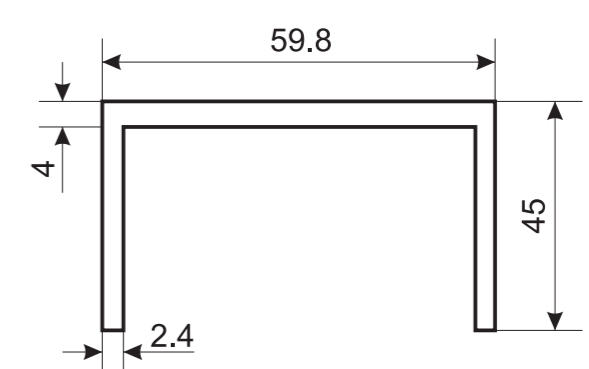

BLA-129

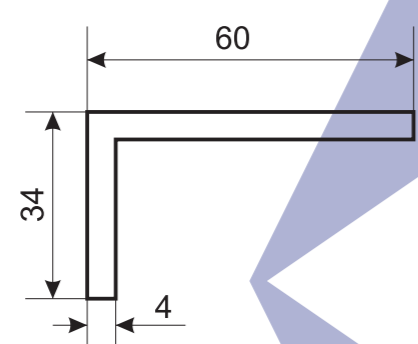

BLA-130

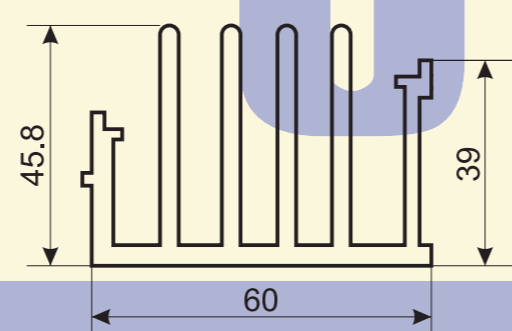

BLA-131

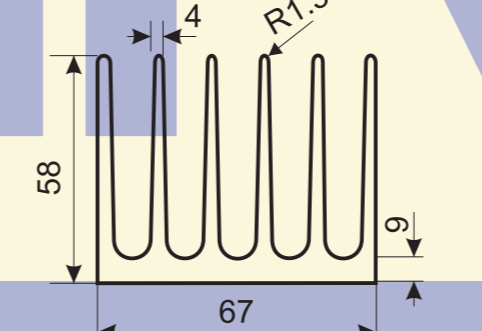

BLA-132

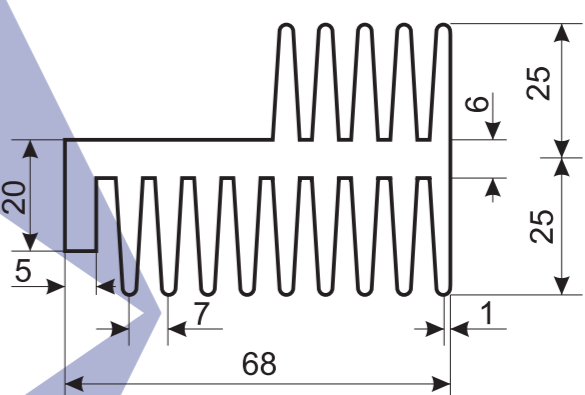

BLA-133

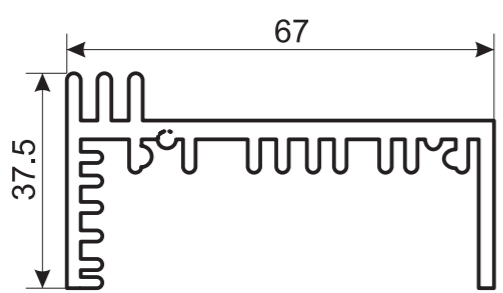

BLA-134

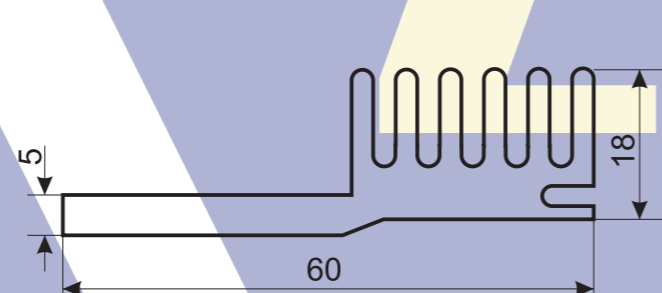

BLA-135

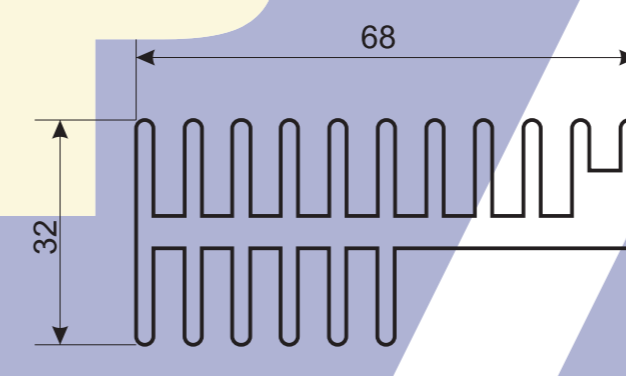

BLA-136

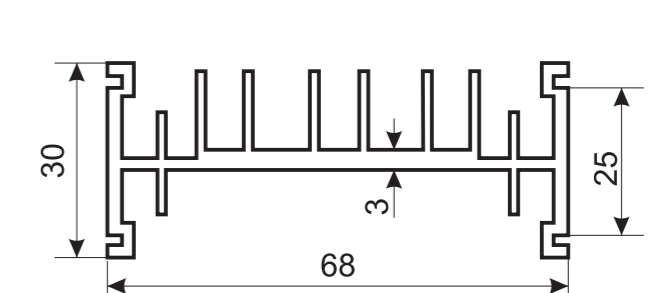

BLA-137

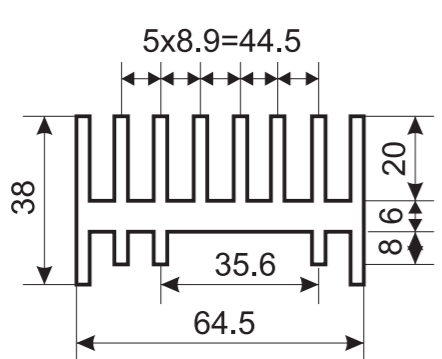

BLA-138

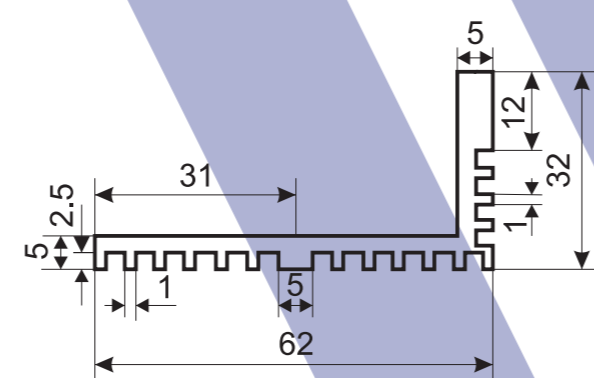

BLA-139

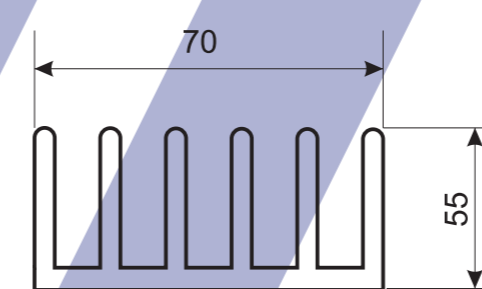

BLA-140

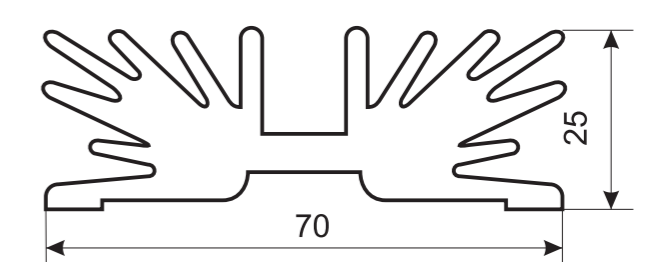

BLA-141

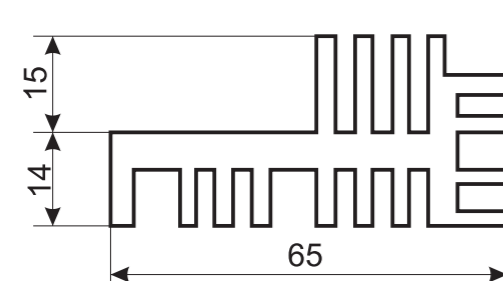

BLA-142

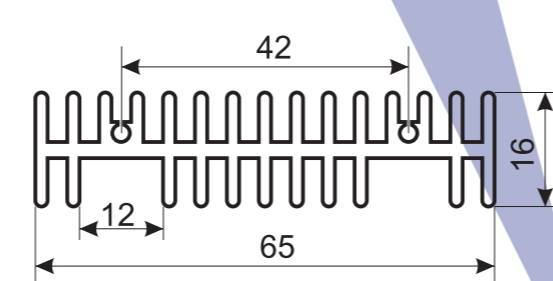

BLA-143

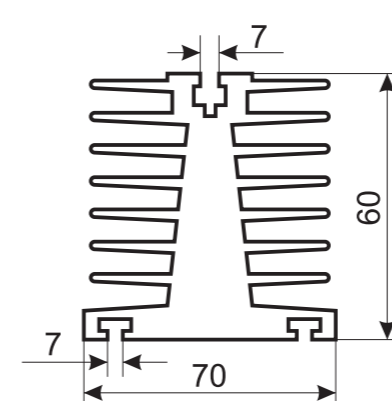

BLA-144

