

## 0603 Green Surface Mount LEDs (1608)

P/N: LLS0603PGC-04

### ·Package Dimensions

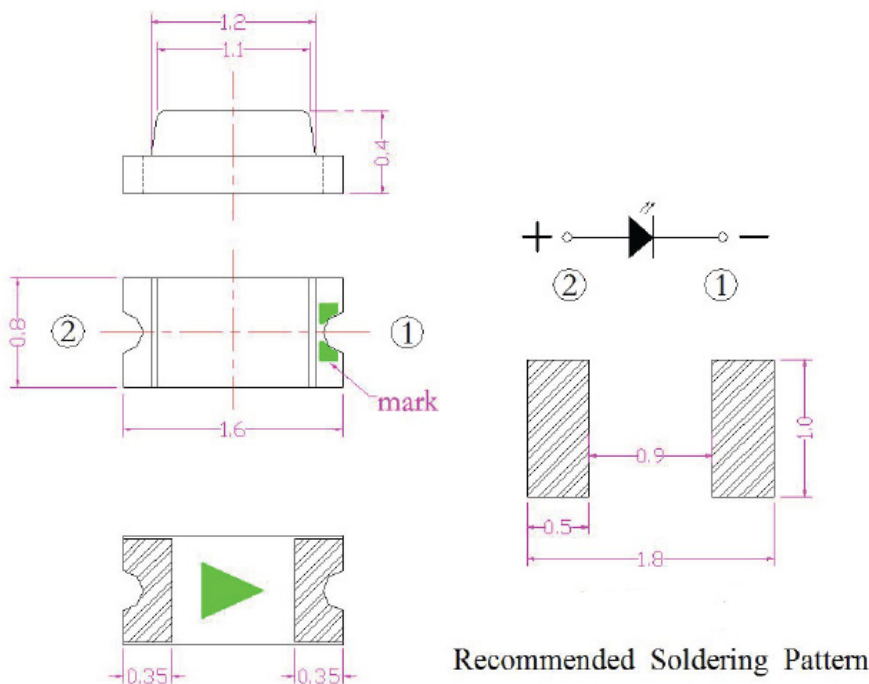

#### NOTES:

1. All dimensions are in millimeter [unit];
2. Tolerance is  $\pm 0.1\text{mm}$  (0.004") unless other specified;
3. Specifications are subject to change without notice.

### ·Features

- 1.6\*0.8\*0.4mm
- Luminous color and colloid: **Green/water clear colloid**
- Environmental protection products Complied with ROHS Directive
- EIA standard packaging
- Suitable for SMT automatic production
- Suitable for reflow soldering process

### ·Application

- Medical equipment: endoscope、ox meter
- Automotive electronics: backlight key light、indicator light
- Industrial products: electronic instrument panel、industrial equipment
- Smart home: white appliances, nixie tube LED
- Communication products: mobile phone button lamp, router

## ·Absolute Maximum Ratings (Ta=25°C)

Item	Symbol	Maximum	Unit
Power Dissipation	$P_d$	70	mW
Continuous Forward Current	$I_{Fmax}$	20	mA
Peak Forward Current(1/10 Duty Cycle 0.1ms Pulse Width)	$I_{FP}$	80	mA
Reverse Voltage	$V_R$	5	V
Antistatic ability	ESD	2000	V
Operating Temperature Range	$T_{opr}$	-30 to+85	°C
Storage Temperature Range	$T_{stg}$	-40 to+85	°C
Lead Solder Temperature	$T_{sol}$	260°C≤6S	

\* Note: Pulse width≤0.1ms, Duty≤1/10

## ·Electrical/Optical Characteristics (Ta=25°C)

Item	Symbol	Condition	Min.	Typ.	Max	Unit
Forward Voltage	$V_F$	$I_F=20mA$	2.6	--	3.0	V
Luminous Intensity	$I_V$	$I_F=20mA$	360	--	474	mcd
Dominant Wavelength	$\lambda_D$	$I_F=20mA$	515	--	535	nm
Peak wavelength	$\lambda_p$	$I_F=20mA$	--	525	--	nm
Half wave width	$\Delta \lambda$	$I_F=20mA$	--	25	--	nm
Viewing Angle	2θ1/2	$I_F=20mA$	---	120	---	Deg
Reverse Current	$I_R$	$V_R =5V$	---	---	5	uA

**·Brightness grading**

CODE	MIN	MAX	UNIT	TEST CONDITIONS
E1	350	400	mcd	IF=20mA
E2	400	450		
E3	450	500		
E4	500	550		
E5	550	600		
E6	600	700		
E7	700	800		

**·Voltage grading**

CODE	MIN	MAX	UNIT	TEST CONDITIONS
M18-7	2.5	2.6	V	IF=20mA
M18-8	2.6	2.7		
M18-9	2.7	2.8		
M19-1	2.8	2.9		
M19-2	2.9	3.0		
M19-3	3.0	3.1		

**·Wavelength grading**

CODE	MIN	MAX	UNIT	TEST CONDITIONS
HG01	510	515	nm	IF=20mA
HG02	515	520		
HG03	520	525		
HG04	525	530		
HG05	530	535		
HG06	535	540		

Typical Electro-Optical Characteristics Curves

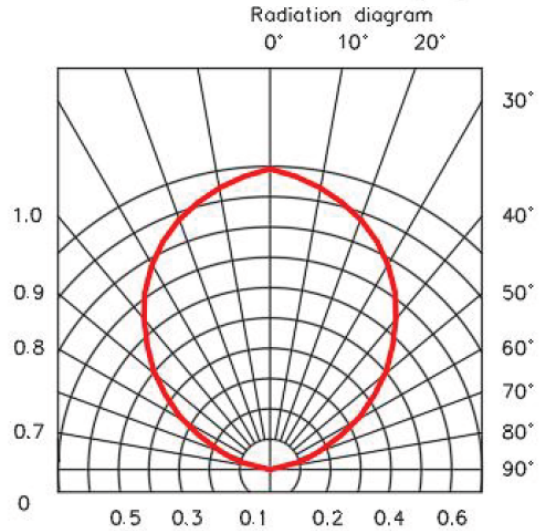
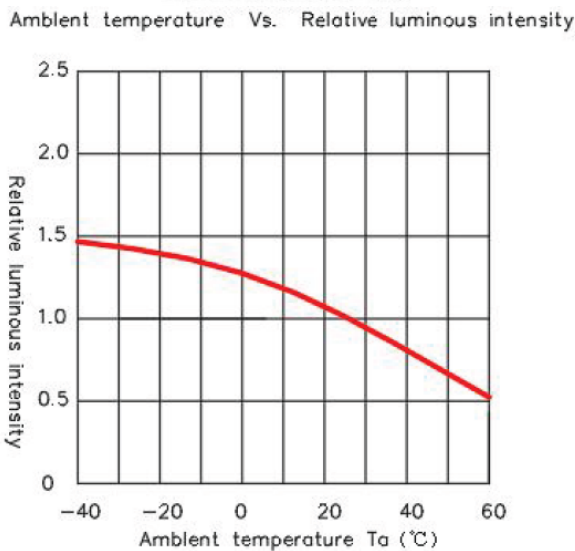
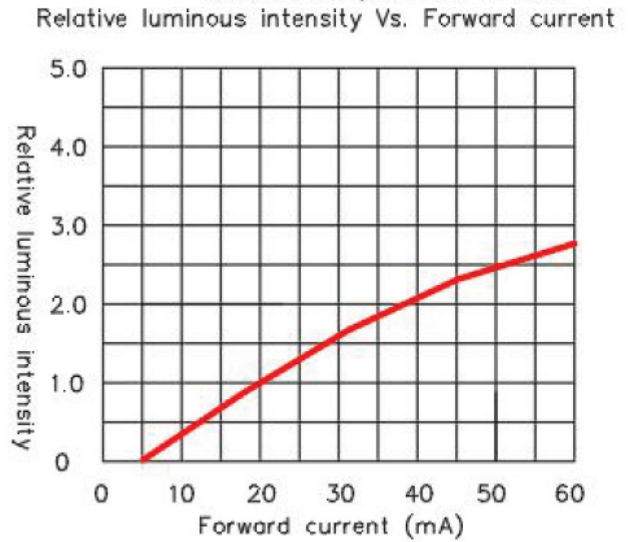
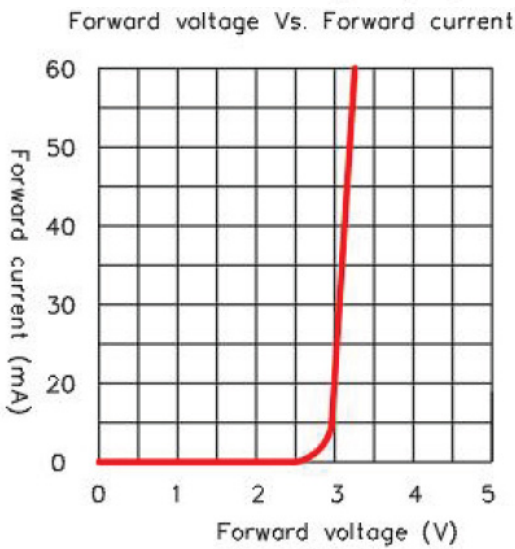
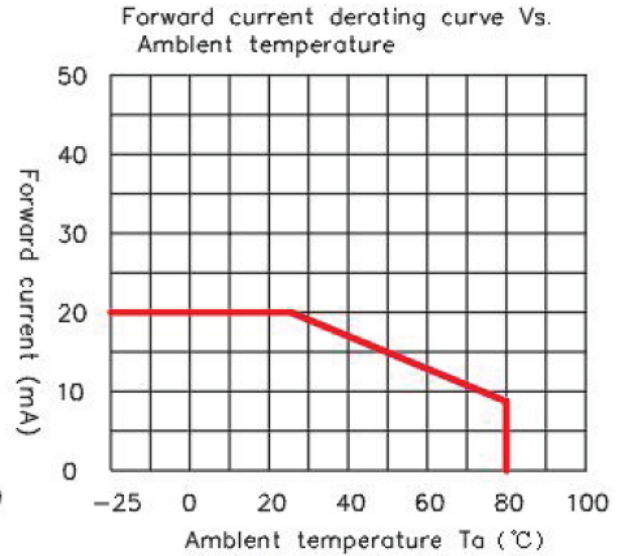
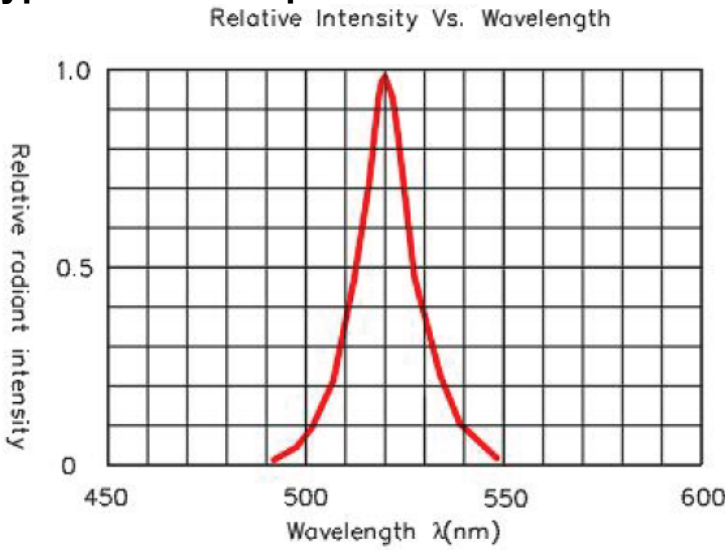

## ·Packaging

Belt and disk dimensions

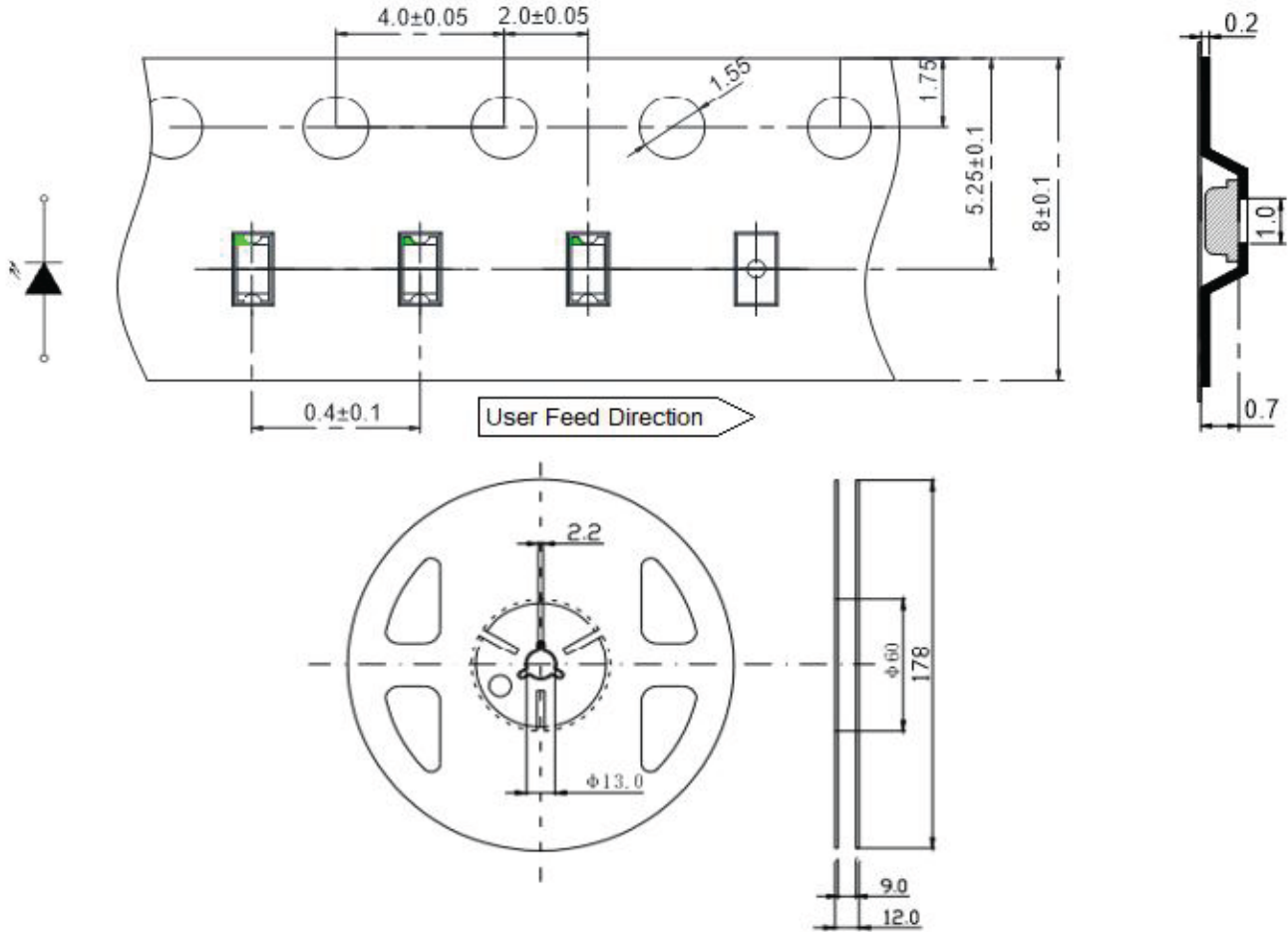

1. Size unit is mm (mm).
2. The dimensional tolerance is  $\pm 0.1\text{mm}$

## ·Disk and carrier belt direction of roll and hole dimensions

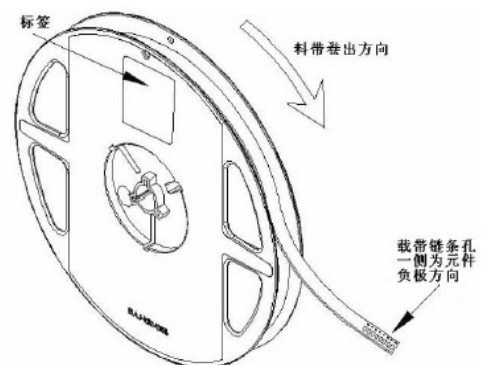
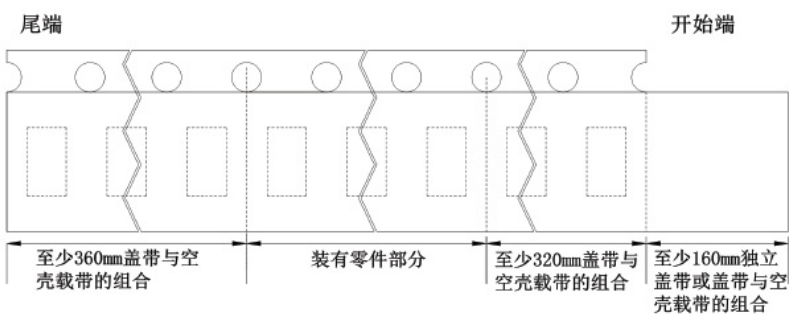

## -Guideline for soldering

### 1. Hand Soldering

Manual welding is recommended only for repair and heavy industry situations. A soldering iron of less than 30W is recommended to be used in Hand Soldering. Please keep the temperature of the soldering iron under 300°C while soldering. Each terminal of the LED is to go for less than 3 second and for one time only. Be careful because the damage of the product is often started at the time of the hand soldering.

### 2. Reflow Soldering: Use the conditions shown in the under Figure of Pb -Free Reflow Soldering

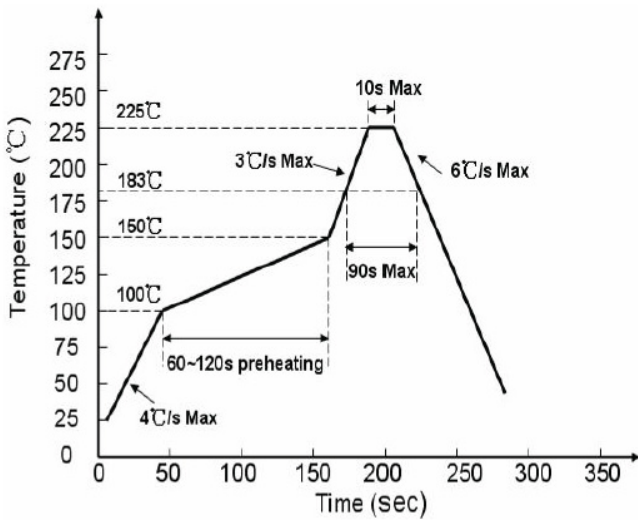

有铅制程 Lead process

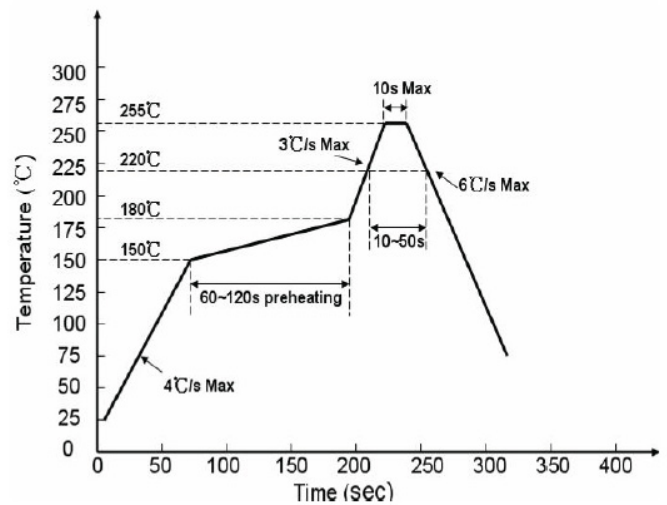

无铅制程 lead free

Reflow soldering should not be done more than two times.

Stress on the LEDs should be avoided during heating in soldering process.

After soldering, do not deal with the product before its temperature drop down to room temperature.

### - Cleaning

It is recommended that alcohol be used as a solvent for cleaning after soldering. Cleaning is to go under 30°C for 3 minutes or 50°C for 30 seconds. When using other solvents, it should be confirmed beforehand whether the solvents will dissolve the package and the resin or not.

Ultrasonic cleaning is also an effective way for cleaning. But the influence of Ultrasonic cleaning on LED depends on factors such as ultrasonic power. Generally, the ultrasonic power should not be higher than 300W. Before cleaning, a pretest should be done to confirm whether any damage to LEDs will occur.

Note: This general guideline may not apply to all PCB designs and configurations of all soldering equipment. The techniques in practice is influenced by many factors, it should be specialized base on the PCB designs and configurations of the soldering equipment..



## •Storage

Moisture proof and anti-electrostatic package with moisture absorbent material is used, to keep moisture to a minimum. Before opening the package, the product should be kept at 30°C or less and humidity less than 60% RH, and be used within a year.

After opening the package, the product should be stored at 30°C or less and humidity less than 10%RH, and be soldered within 168 hours (7 days). It is recommended that the product be operated at the workshop condition of 30°C or less and humidity less than 60%RH.

If the moisture absorbent material has fade away or the LEDs have exceeded the storage time, baking treatment should be performed based on the following condition: (60±5)°C for 24 hours.

## •Static Electricity

Static electricity or surge voltage damages the LEDs. Damaged LEDs will show some unusual characteristic such as the forward voltage becomes lower, or the LEDs do not light at the low current. Even not light.

All devices, equipment and machinery must be properly grounded. At the same time, it is recommended that wrist bands or anti-electrostatic gloves, anti-electrostatic containers be used when dealing with the LEDs.

## •Design Consideration

In designing a circuit, the current through each LED must not exceed the absolute maximum rating specified for each LED. In the meanwhile, resistors for protection should be applied, otherwise slight voltage shift will cause big current change, burn out may happen.

It is recommended to use Circuit A which regulates the current flowing through each LED rather than Circuit B. When driving LEDs with a constant voltage in Circuit B, the current through the LEDs may vary due to the variation in Forward Voltage (VF) of the LEDs. In the worst case, some LED may be subjected to stresses in excess of the Absolute Maximum Rating.

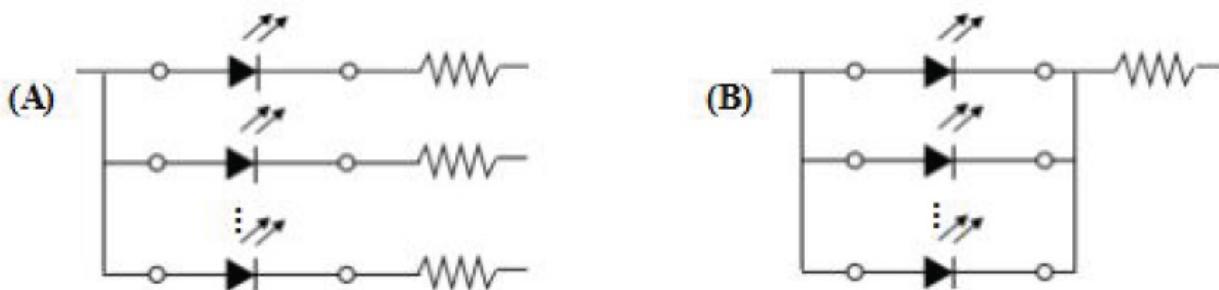

Thermal Design is paramount importance because heat generation may result in the Characteristics decline, such as brightness decreased, Color changed and so on. Please consider the heat generation of the LEDs when making the system design.

**·Others**

When handling the product, touching the encapsulate with bare hands will not only contaminate its surface, But also affect on its optical characteristics. Excessive force to the encapsulate might result in catastrophic failure of the LEDs due to die breakage or wire deformation. For this reason, please do not put excessive stress on LEDs, especially when the LEDs are heated such as during Reflow Soldering.

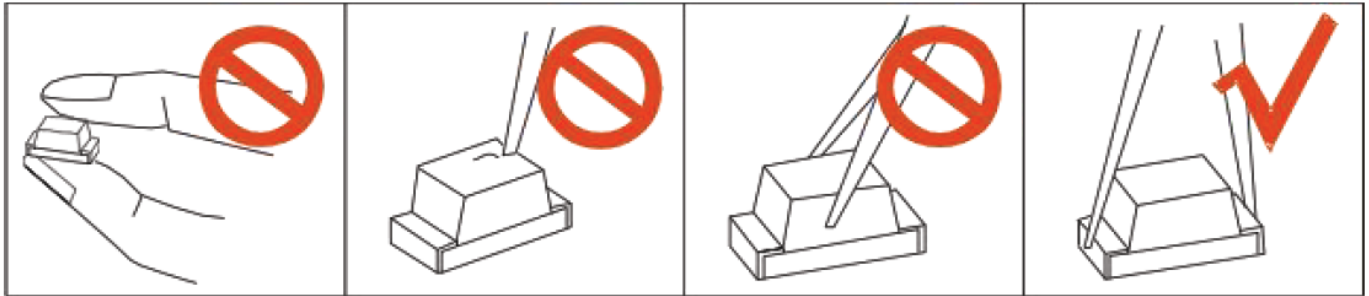

The epoxy resin of encapsulate is fragile, so please avoid scratch or friction over the epoxy resin surface. While handling the product with tweezers, do not hold by the epoxy resin, be careful.

**·Safety Advice for Human Eyes**

Viewing direct to the light emitting center of the LEDs, especially those of great Luminous Intensity, will cause great hazard to human eyes. Please be careful.