

FEATURES

Easy to Use
Low Power

1 mA Power Supply Current (5 mW on +5 V_S)

High Speed and Fast Settling on +5 V

300 MHz, -3 dB Bandwidth (G = +1)

180 MHz, -3 dB Bandwidth (G = +2)

2000 V/μs Slew Rate

29 ns Settling Time to 0.1%

Good Video Specifications (R_L = 1 kΩ, G = +2)

Gain Flatness 0.1 dB to 25 MHz

0.02% Differential Gain Error

0.06° Differential Phase Error

Low Distortion

-70 dBc Worst Harmonic @ 5 MHz

-62 dBc Worst Harmonic @ 20 MHz

Single Supply Operation

Fully Specified for +5 V Supply

APPLICATIONS

Power Sensitive, High Speed Systems

Video Switchers

Distribution Amplifiers

A-to-D Driver

Professional Cameras

CCD Imaging Systems

Ultrasound Equipment (Multichannel)

PRODUCT DESCRIPTION

The AD8011 is a very low power, high-speed amplifier designed to operate on +5 V or ±5 V supplies. With wide bandwidth, low distortion and low power, this device is ideal as a general-purpose

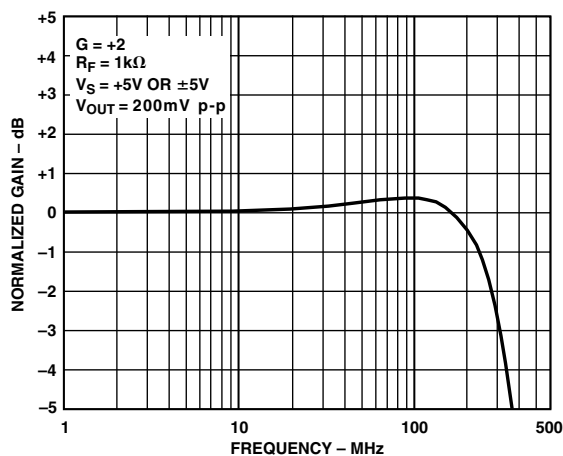

Figure 1. Frequency Response; G = +2, V_S = +5 V or ±5 V

*Protected under Patent Number 5,537,079.

REV. B

Information furnished by Analog Devices is believed to be accurate and reliable. However, no responsibility is assumed by Analog Devices for its use, nor for any infringements of patents or other rights of third parties which may result from its use. No license is granted by implication or otherwise under any patent or patent rights of Analog Devices.

FUNCTIONAL BLOCK DIAGRAM

8-Lead Plastic DIP and SOIC

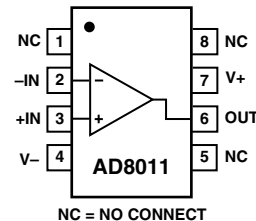

amplifier. It also can be used to replace high-speed amplifiers consuming more power. The AD8011 is a current feedback amplifier and features gain flatness of 0.1 dB to 25 MHz while offering differential gain and phase error of 0.02% and 0.06° on a single +5 V supply. This makes the AD8011 ideal for professional video electronics such as cameras, video switchers or any high speed portable equipment. Additionally, the AD8011's low distortion and fast settling make it ideal for buffering high speed 8-, 10-, 12-bit A-to-D converters.

The AD8011 offers very low power of 1 mA max and can run on single +5 V to +12 V supplies. All this is offered in a small 8-lead plastic DIP or 8-lead SOIC package. These features fit well with portable and battery-powered applications where size and power are critical.

The AD8011 is available in the industrial temperature range of -40°C to +85°C.

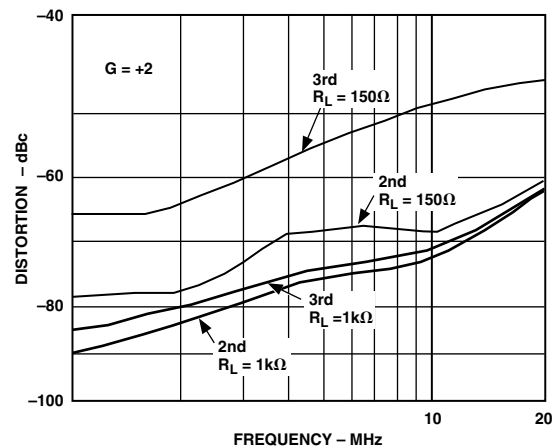

Figure 2. Distortion vs. Frequency; V_S = ±5 V

AD8011—SPECIFICATIONS

DUAL SUPPLY (@ $T_A = +25^\circ\text{C}$, $V_S = \pm 5\text{ V}$, $G = +2$, $R_F = 1\text{ k}\Omega$, $R_L = 1\text{ k}\Omega$, unless otherwise noted)

Model	Conditions	AD8011A			Units
		Min	Typ	Max	
DYNAMIC PERFORMANCE					
-3 dB Small Signal Bandwidth, $V_O < 1\text{ V p-p}$	$G = +1$	340	400		MHz
-3 dB Small Signal Bandwidth, $V_O < 1\text{ V p-p}$	$G = +2$	180	210		MHz
-3 dB Large Signal Bandwidth, $V_O = 5\text{ V p-p}$	$G = +10$, $R_F = 500\ \Omega$		57		MHz
Bandwidth for 0.1 dB Flatness	$G = +2$	20	25		MHz
Slew Rate	$G = +2$, $V_O = 4\text{ V Step}$		3500		V/ μs
	$G = -1$, $V_O = 4\text{ V Step}$		1100		V/ μs
Settling Time to 0.1%	$G = +2$, $V_O = 2\text{ V Step}$		25		ns
Rise and Fall Time	$G = +2$, $V_O = 2\text{ V Step}$		0.4		ns
	$G = -1$, $V_O = 2\text{ V Step}$		3.7		ns
NOISE/HARMONIC PERFORMANCE					
2nd Harmonic	$f_C = 5\text{ MHz}$, $V_O = 2\text{ V p-p}$, $G = +2$ $R_L = 1\text{ k}\Omega$		-75		dB
	$R_L = 150\ \Omega$		-67		dB
3rd Harmonic	$R_L = 1\text{ k}\Omega$		-70		dB
	$R_L = 150\ \Omega$		-54		dB
Input Voltage Noise	$f = 10\text{ kHz}$		2		nV/ $\sqrt{\text{Hz}}$
Input Current Noise	$f = 10\text{ kHz}$, +In		5		pA/ $\sqrt{\text{Hz}}$
	-In		5		pA/ $\sqrt{\text{Hz}}$
Differential Gain Error	NTSC, $G = +2$, $R_L = 1\text{ k}\Omega$		0.02		%
	$R_L = 150\ \Omega$		0.02		%
Differential Phase Error	NTSC, $G = +2$, $R_L = 1\text{ k}\Omega$		0.06		Degrees
	$R_L = 150\ \Omega$		0.3		Degrees
DC PERFORMANCE					
Input Offset Voltage			2	5	$\pm\text{mV}$
	$T_{\text{MIN}}-T_{\text{MAX}}$		2	6	$\pm\text{mV}$
Offset Drift			10		$\mu\text{V}/^\circ\text{C}$
-Input Bias Current			5	15	$\pm\mu\text{A}$
	$T_{\text{MIN}}-T_{\text{MAX}}$			20	$\pm\mu\text{A}$
+Input Bias Current			5	15	$\pm\mu\text{A}$
	$T_{\text{MIN}}-T_{\text{MAX}}$			20	$\pm\mu\text{A}$
Open-Loop Transresistance		800	1300		k Ω
	$T_{\text{MIN}}-T_{\text{MAX}}$	550			k Ω
INPUT CHARACTERISTICS					
Input Resistance	+Input		450		k Ω
Input Capacitance	+Input		2.3		pF
Input Common-Mode Voltage Range		3.8	4.1		$\pm\text{V}$
Common-Mode Rejection Ratio					dB
Offset Voltage	$V_{\text{CM}} = \pm 2.5\text{ V}$	-52	-57		dB
OUTPUT CHARACTERISTICS					
Output Voltage Swing		3.9	4.1		$\pm\text{V}$
Output Resistance			0.1	0.3	Ω
Output Current	$T_{\text{MIN}}-T_{\text{MAX}}$	15	30		mA
Short Circuit Current			60		mA
POWER SUPPLY					
Operating Range		± 1.5		± 6.0	V
Quiescent Current	$T_{\text{MIN}}-T_{\text{MAX}}$		1.0	1.3	mA
Power Supply Rejection Ratio	$V_S = \pm 5\text{ V} \pm 1\text{ V}$	55	58		dB

Specifications subject to change without notice.

SINGLE SUPPLY (@ $T_A = +25^\circ\text{C}$, $V_S = +5\text{ V}$, $G = +2$, $R_F = 1\text{ k}\Omega$, $V_{CM} = 2.5\text{ V}$, $R_L = 1\text{ k}\Omega$, unless otherwise noted)

Model	Conditions	AD8011A			Units
		Min	Typ	Max	
DYNAMIC PERFORMANCE					
-3 dB Small Signal Bandwidth, $V_O < 0.5\text{ V p-p}$	$G = +1$	270	328		MHz
-3 dB Small Signal Bandwidth, $V_O < 0.5\text{ V p-p}$	$G = +2$	150	180		MHz
-3 dB Large Signal Bandwidth, $V_O = 2.5\text{ V p-p}$	$G = +10$, $R_F = 500\ \Omega$		57		MHz
Bandwidth for 0.1 dB Flatness	$G = +2$	15	20		MHz
Slew Rate	$G = +2$, $V_O = 2\text{ V Step}$		2000		V/ μs
	$G = -1$, $V_O = 2\text{ V Step}$		500		V/ μs
Settling Time to 0.1%	$G = +2$, $V_O = 2\text{ V Step}$		29		ns
Rise and Fall Time	$G = +2$, $V_O = 2\text{ V Step}$		0.6		ns
	$G = -1$, $V_O = 2\text{ V Step}$		4		ns
NOISE/HARMONIC PERFORMANCE					
2nd Harmonic	$f_C = 5\text{ MHz}$, $V_O = 2\text{ V p-p}$, $G = +2$ $R_L = 1\text{ k}\Omega$		-84		dB
	$R_L = 150\ \Omega$		-67		dB
3rd Harmonic	$R_L = 1\text{ k}\Omega$		-76		dB
	$R_L = 150\ \Omega$		-54		dB
Input Voltage Noise	$f = 10\text{ kHz}$		2		nV/ $\sqrt{\text{Hz}}$
Input Current Noise	$f = 10\text{ kHz}$, +In		5		pA/ $\sqrt{\text{Hz}}$
	-In		5		pA/ $\sqrt{\text{Hz}}$
Differential Gain Error	NTSC, $G = +2$, $R_L = 1\text{ k}\Omega$		0.02		%
	$R_L = 150\ \Omega$		0.6		%
Differential Phase Error	NTSC, $G = +2$, $R_L = 1\text{ k}\Omega$		0.06		Degrees
	$R_L = 150\ \Omega$		0.8		Degrees
DC PERFORMANCE					
Input Offset Voltage			2	5	mV
	$T_{MIN}-T_{MAX}$		2	6	mV
Offset Drift			10		$\mu\text{V}/^\circ\text{C}$
-Input Bias Current			5	15	$\pm\mu\text{A}$
	$T_{MIN}-T_{MAX}$			20	$\pm\mu\text{A}$
+Input Bias Current			5	15	$\pm\mu\text{A}$
	$T_{MIN}-T_{MAX}$			20	$\pm\mu\text{A}$
Open-Loop Transresistance		800	1300		k Ω
	$T_{MIN}-T_{MAX}$	550			k Ω
INPUT CHARACTERISTICS					
Input Resistance	+Input		450		k Ω
Input Capacitance	+Input		2.3		pF
Input Common-Mode Voltage Range		1.5 to 3.5	1.2 to 3.8		V
Common-Mode Rejection Ratio					dB
Offset Voltage	$V_{CM} = 1.5\text{ V to }3.5\text{ V}$	-52	-57		dB
OUTPUT CHARACTERISTICS					
Output Voltage Swing		1.2 to 3.8	0.9 to 4.1		+V
Output Resistance			0.1	0.3	Ω
Output Current	$T_{MIN}-T_{MAX}$	15	30		mA
Short Circuit Current			50		mA
POWER SUPPLY					
Operating Range		+3		+12	V
Quiescent Current	$T_{MIN}-T_{MAX}$		0.8	1.15	mA
Power Supply Rejection Ratio	$\Delta V_S = \pm 1\text{ V}$	55	58		dB

Specifications subject to change without notice.

AD8011

ABSOLUTE MAXIMUM RATINGS¹

Supply Voltage	12.6 V
Internal Power Dissipation ²	
Plastic DIP Package (N)	Observe Derating Curves
Small Outline Package (R)	Observe Derating Curves
Input Voltage (Common Mode)	$\pm V_S$
Differential Input Voltage	± 2.5 V
Output Short Circuit Duration	Observe Power Derating Curves
Storage Temperature Range (N, R)	-65°C to +125°C
Operating Temperature Range (A Grade)	-40°C to +85°C
Lead Temperature Range (Soldering 10 sec)	+300°C

NOTES

¹Stresses above those listed under Absolute Maximum Ratings may cause permanent damage to the device. This is a stress rating only; functional operation of the device at these or any other conditions above those indicated in the operational section of this specification is not implied. Exposure to absolute maximum rating conditions for extended periods may affect device reliability.

²Specification is for device in free air:
 8-Lead Plastic DIP Package: $\theta_{JA} = 90^\circ\text{C}/\text{W}$
 8-Lead SOIC Package: $\theta_{JA} = 155^\circ\text{C}/\text{W}$

MAXIMUM POWER DISSIPATION

The maximum power that can be safely dissipated by the AD8011 is limited by the associated rise in junction temperature. The maximum safe junction temperature for plastic encapsulated devices is determined by the glass transition temperature of the plastic, approximately +150°C. Exceeding this limit temporarily may cause a shift in parametric performance due to a change in the stresses exerted on the die by the package. Exceeding a junction temperature of +175°C for an extended period can result in device failure.

While the AD8011 is internally short circuit protected, this may not be sufficient to guarantee that the maximum junction temperature is not exceeded under all conditions. To ensure proper operation, it is necessary to observe the maximum power derating curves (shown below in Figure 3).

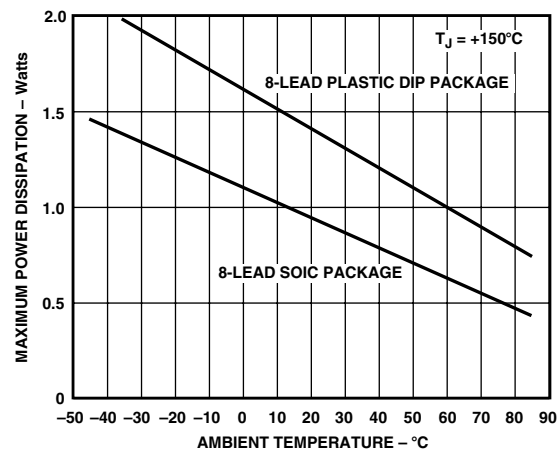

Figure 3. Maximum Power Dissipation vs. Temperature

ORDERING GUIDE

Model	Temperature Range	Package Description	Package Option
AD8011AN	-40°C to +85°C	8-Lead Plastic DIP	N-8
AD8011AR	-40°C to +85°C	8-Lead SOIC	SO-8
AD8011AR-REEL	-40°C to +85°C	13" Tape and Reel	SO-8
AD8011AR-REEL7	-40°C to +85°C	7" Tape and Reel	SO-8
AD8011-EB		Evaluation Board	

CAUTION

ESD (electrostatic discharge) sensitive device. Electrostatic charges as high as 4000 V readily accumulate on the human body and test equipment and can discharge without detection. Although the AD8011 features proprietary ESD protection circuitry, permanent damage may occur on devices subjected to high energy electrostatic discharges. Therefore, proper ESD precautions are recommended to avoid performance degradation or loss of functionality.



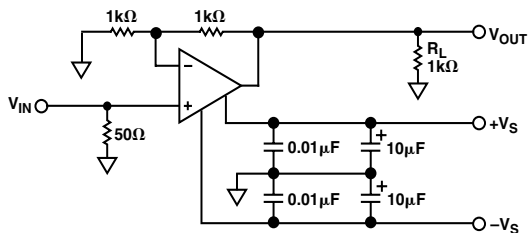

Figure 4. Test Circuit; Gain = +2

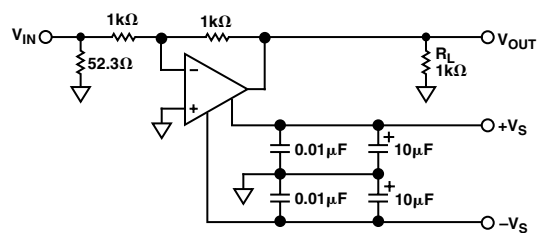

Figure 7. Test Circuit; Gain = -1

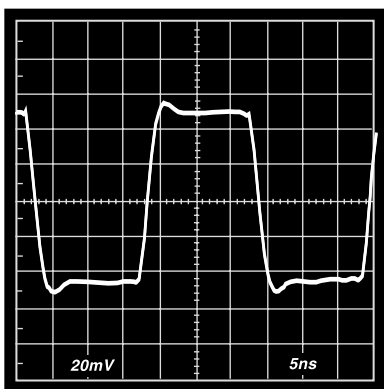

Figure 5.* 100 mV Step Response; $G = +2$, $V_S = \pm 2.5 \text{ V}$ or $\pm 5 \text{ V}$

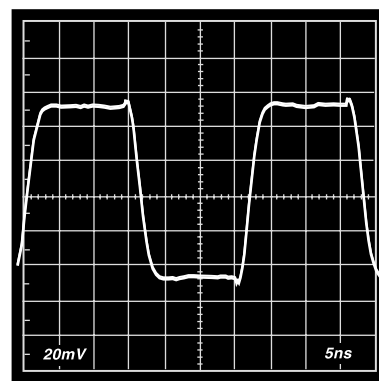

Figure 8.* 100 mV Step Response; $G = -1$, $V_S = \pm 2.5 \text{ V}$ or $\pm 5 \text{ V}$

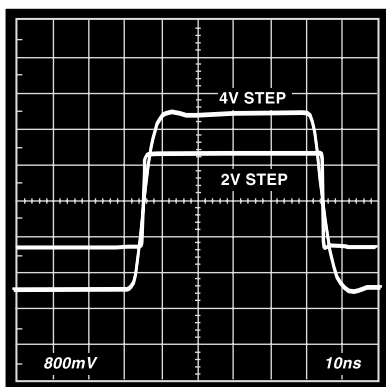

Figure 6.* Step Response; $G = +2$, $V_S = \pm 2.5 \text{ V}$ (2 V Step) and $\pm 5 \text{ V}$ (4 V Step)

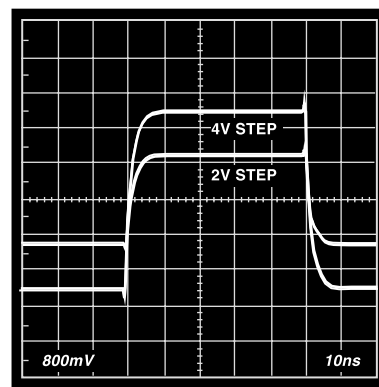

Figure 9.* Step Response; $G = -1$, $V_S = \pm 2.5 \text{ V}$ (2 V Step) and $\pm 5 \text{ V}$ (4 V Step)

*NOTE: $V_S = \pm 2.5 \text{ V}$ operation is identical to $V_S = +5 \text{ V}$ single supply operation.

AD8011

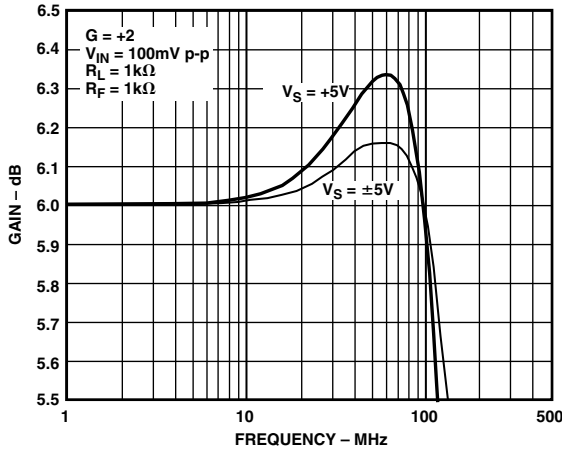

Figure 10. Gain Flatness; $G = +2$

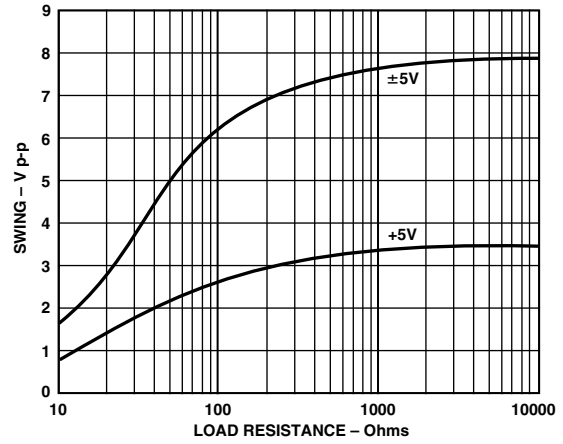

Figure 13. Output Voltage Swing vs. Load

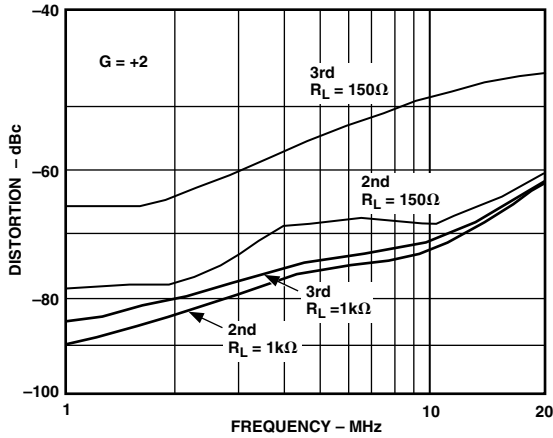

Figure 11. Distortion vs. Frequency; $V_S = \pm 5 V$

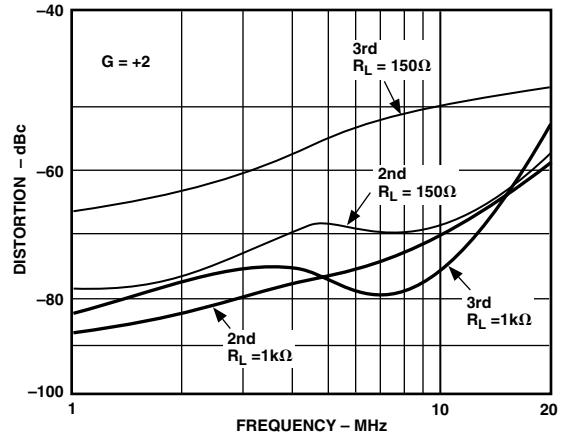

Figure 14. Distortion vs. Frequency; $V_S = +5 V$

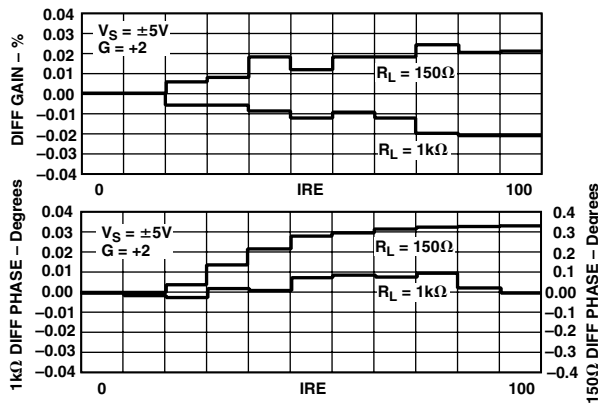

Figure 12. Diff Phase and Diff Gain; $V_S = \pm 5 V$

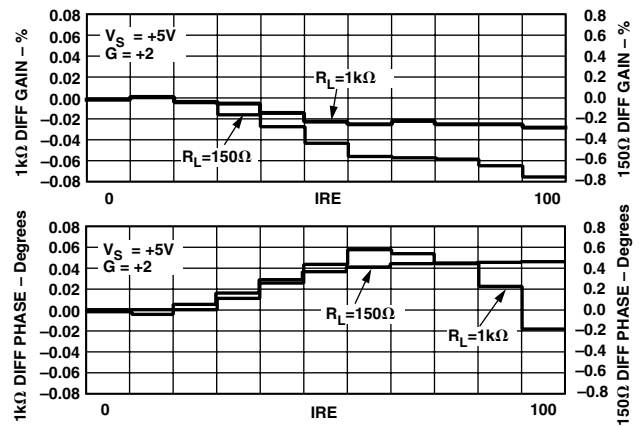

Figure 15. Diff Phase and Diff Gain; $V_S = +5 V$

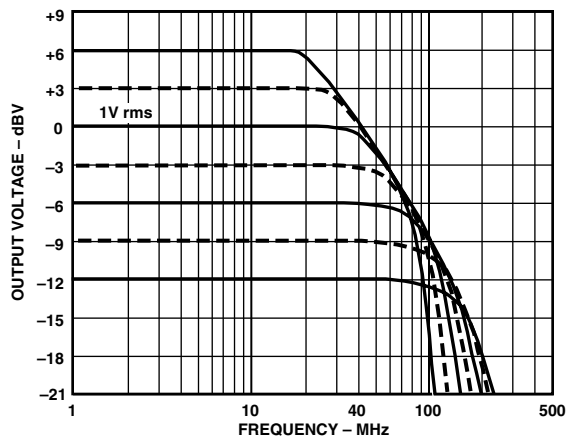

Figure 16. Large Signal Frequency Response; $V_S = \pm 5\text{ V}$, $G = +2$

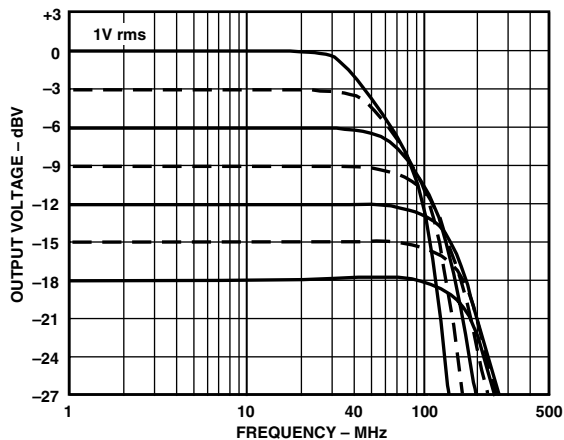

Figure 19. Large Signal Frequency Response; $V_S = +5\text{ V}$, $G = +2$

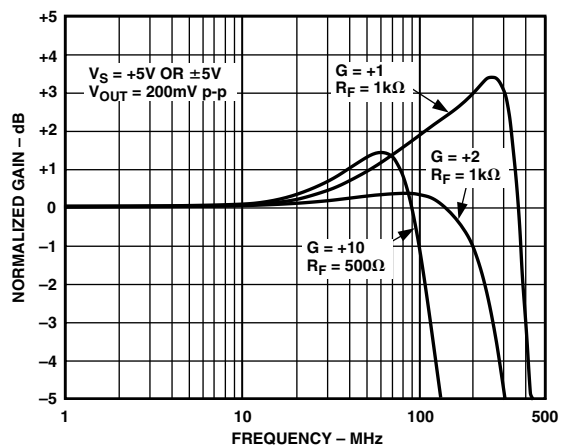

Figure 17. Frequency Response; $G = +1, +2, +10$; $V_S = +5\text{ V}$ or $\pm 5\text{ V}$

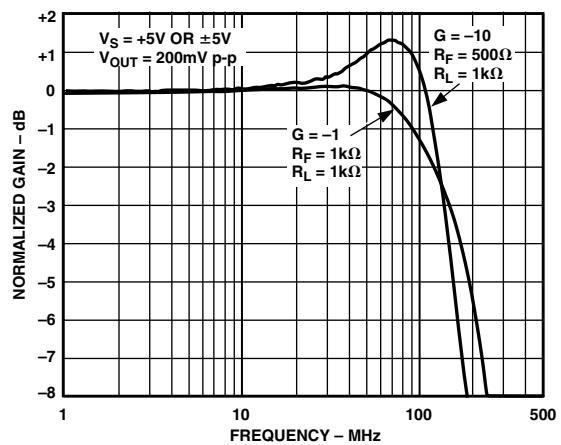

Figure 18. Frequency Response; $G = -1, -10$; $V_S = +5\text{ V}$ or $\pm 5\text{ V}$

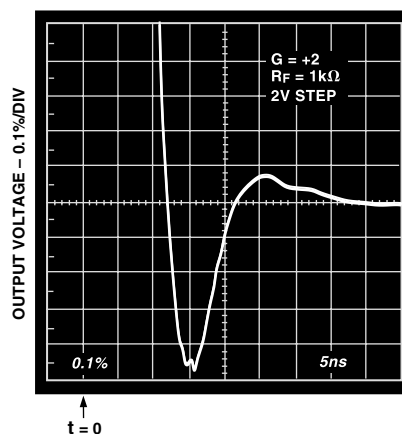

Figure 20. Short-Term Settling Time; $V_S = +5\text{ V}$ or $\pm 5\text{ V}$

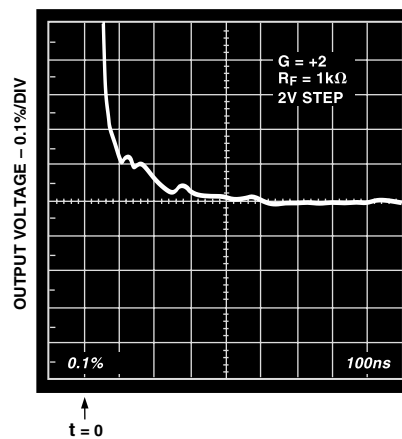

Figure 21. Long-Term Settling Time; $V_S = +5\text{ V}$ or $\pm 5\text{ V}$

AD8011

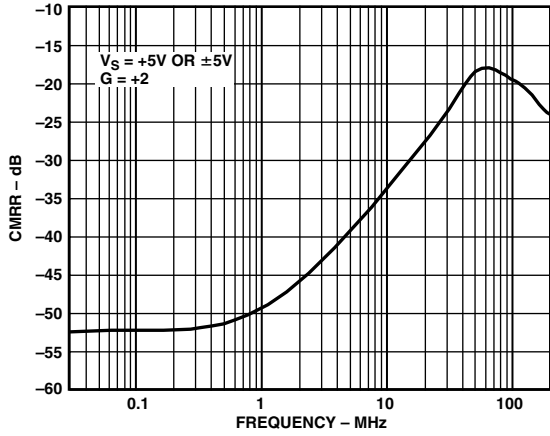

Figure 22. CMRR vs. Frequency; $V_S = +5\text{ V}$ or $\pm 5\text{ V}$

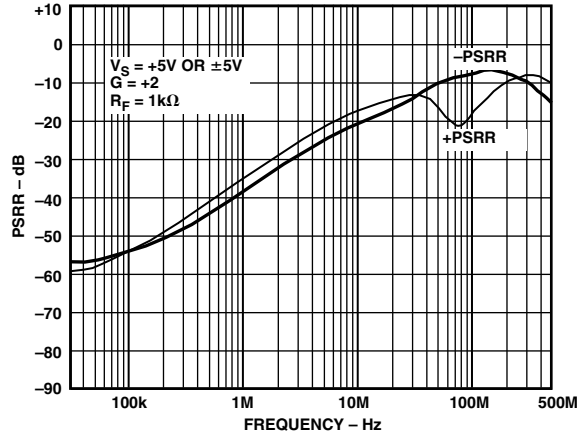

Figure 25. PSRR vs. Frequency; $V_S = +5\text{ V}$ or $\pm 5\text{ V}$

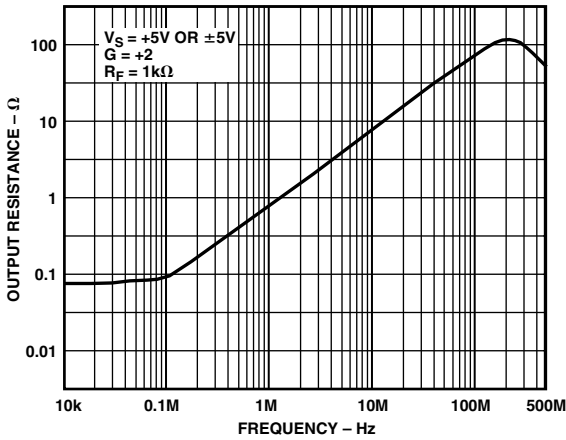

Figure 23. Output Resistance vs. Frequency; $V_S = +5\text{ V}$ or $\pm 5\text{ V}$

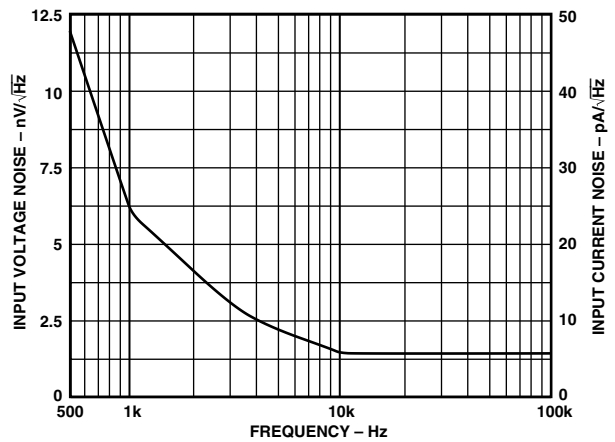

Figure 26. Noise vs. Frequency; $V_S = +5\text{ V}$ or $\pm 5\text{ V}$

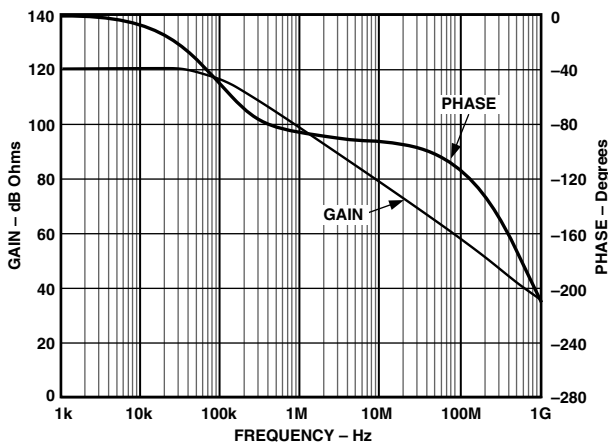

Figure 24. Transimpedance Gain and Phase vs. Frequency

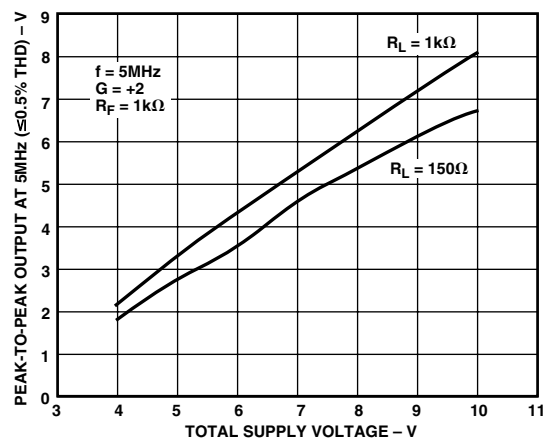

Figure 27. Output Swing vs. Supply

THEORY OF OPERATION

The AD8011 is a revolutionary generic high-speed CF amplifier that attains new levels of BW, power, distortion, and signal swing capability. If these key parameters were combined as a figure of ac merit performance or [(frequency × V_{SIG})/(distortion × power)], no IC amplifier today would come close to the merit value of the AD8011 for frequencies above a few MHz. Its wide dynamic performance (including noise) is the result of both a new complementary high speed bipolar process and a new and unique architectural design. The AD8011 uses basically a two gain stage complementary design approach versus the traditional “single stage” complementary mirror structure sometimes referred to as the Nelson amplifier. Though twin stages have been tried before, they typically consumed high power since they were of a folded cascade design much like the AD9617. This design allows for the standing or quiescent current to add to the high signal or slew current induced stages much like the Nelson or single stage design. Thus, in the time domain, the large signal output rise/fall time and slew rate is controlled typically by the small signal BW of the amplifier and the input signal step amplitude respectively, not the dc quiescent current of the gain stages (with the exception of input level shift diodes Q1/Q2). Using two stages vs. one also allows for a higher overall gain bandwidth product (GBWP) for the same power, thus lower signal distortion and the ability to drive heavier external loads. In addition, the second gain stage also isolates (divides down) A3’s input reflected load drive and the nonlinearities created resulting in relatively lower distortion and higher open-loop gain.

Overall, when “high” external load drive and low ac distortion is a requirement, a twin gain stage integrating amplifier like the AD8011 will provide superior results for lower power over the traditional single stage complementary devices. In addition, being a CF amplifier, closed-loop BW variations versus external gain variations (varying R_N) will be much lower compared to a VF op amp, where the BW varies inversely with gain. Another key attribute of this amplifier is its ability to run on a single 5 V supply due in part to its wide common-mode input and output voltage range capability. For 5 V supply operation, the device obviously consumes half the quiescent power (vs. 10 V supply) with little degradation in its ac and dc performance characteristics. See data sheet comparisons.

DC GAIN CHARACTERISTICS

Gain stages A1/A1B and A2/A2B combined provide negative feedforward transresistance gain. See Figure 28. Stage A3 is a unity gain buffer which provides external load isolation to A2. Each stage uses a symmetrical complementary design. (A3 is also complementary though not explicitly shown). This is done to both reduce second order signal distortion and overall quiescent power as discussed above. In the quasi dc to low frequency region, the closed loop gain relationship can be approximated as:

$$G = 1 + R_F/R_N \quad \text{noninverting operation}$$

$$G = -R_F/R_N \quad \text{inverting operation}$$

These basic relationships above are common to all traditional operational amplifiers. Due to the inverting input error current (I_E) required to servo the output and the inverting I_E × R_I drop

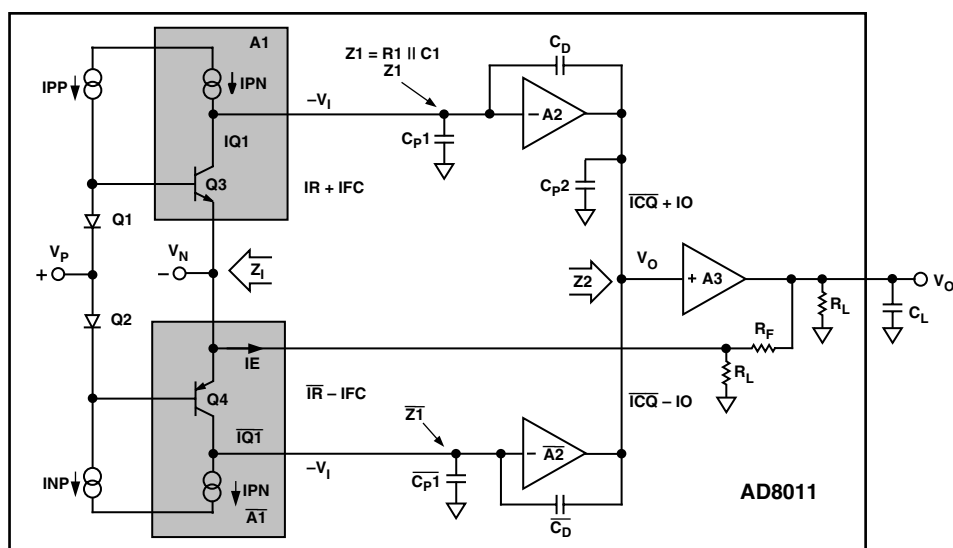

Figure 28. Simplified Block Diagram

AD8011

(error current times the open loop inverting input resistance) that results (see Figure 29), a more exact low frequency closed loop transfer functions can be described as:

$$A_V = \frac{G}{1 + \frac{G \times R_I}{T_O} + \frac{R_F}{T_O}} = \frac{G}{1 + \frac{G}{A_O} + \frac{R_F}{T_O}}$$

for noninverting (G is positive)

$$A_V = \frac{G}{1 + \frac{1-G}{A_O} + \frac{R_F}{T_O}}$$

for inverting (G is negative)

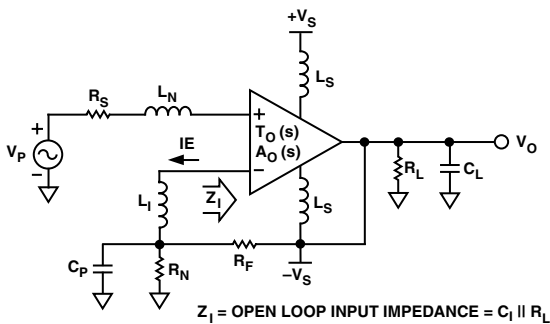

Figure 29. Z_I = Open-Loop Input Impedance

where G is the ideal gain as previously described. With $R_I = T_O/A_O$ (open-loop inverting input resistance), the second expression (positive G) clearly relates to the classical voltage feedback “op amp” equation with T_O omitted do to its relatively much higher value and thus insignificant effect. A_O and T_O are the open-loop dc voltage and transresistance gains of the amplifier respectively. These key transfer variables can be described as:

$$A_O = \frac{R_I \times g_{mf} \times |A_2|}{(1 - g_{mc} \times R_I)} \quad \text{and} \quad T_O = \frac{R_I \times |A_2|}{2}; \quad \text{therefore} \quad R_I = \frac{1 - g_{mc} \times R_I}{2 \times g_{mf}}$$

Where g_{mc} is the positive feedback transconductance (not shown) and $1/g_{mf}$ is the thermal emitter resistance of devices D1/D2 and Q3/Q4. The $g_{mc} \times R_I$ product has a design value that results in a negative dc open loop gain of typically -2500 V/V (see Figure 30).

Though atypical of conventional CF or VF amps, this negative open-loop voltage gain results in an input referred error term $(V_P - V_O/G = G/A_O + R_F/T_O)$ that will typically be negative for G greater than $+3/-4$. As an example, for $G = 10$, $A_O = -2500$ and $T_O = 1.2$ M Ω , results in a error of -3 mV using the A_V derivation above.

This analysis assumes perfect current sources and infinite transistor V_{AS} (Q3, Q4 output conductances are assumed zero). These assumptions result in actual vs. model open loop voltage gain and associated input referred error terms being less accurate for low gain (G) noninverting operation at the frequencies below the open loop pole of the AD8011. This is primarily a result of the input signal (V_P) modulating the output conductances of Q3/Q4 resulting in R_I less negative than derived here. For inverting operation, the actual vs. model dc error terms are relatively much less.

AC TRANSFER CHARACTERISTICS

The ac small signal transfer derivations below are based on a simplified single-pole model. Though inaccurate at frequencies approaching the closed-loop BW (CLBW) of the AD8011 at low noninverting external gains, they still provide a fair approximation and a intuitive understanding of its primary ac small signal characteristics.

For inverting operation and high noninverting gains these transfer equations provide a good approximation to the actual ac performance of the device.

To accurately quantify the V_O vs. V_P relationship, both $A_O(s)$ and $T_O(s)$ need to be derived. This can be seen by the following nonexpanded noninverting gain relationship:

$$V_O(s)/V_P(s) = \frac{G}{\frac{G}{A_O[s]} + \frac{R_F}{T_O[s]} + 1}$$

with

$$A_O(s) = \frac{R_I \times g_{mf} \times |A_2|}{\frac{1 - g_{mc} \times R_I}{s + 1}} \frac{1}{1 - g_{mc} \times R_I}$$

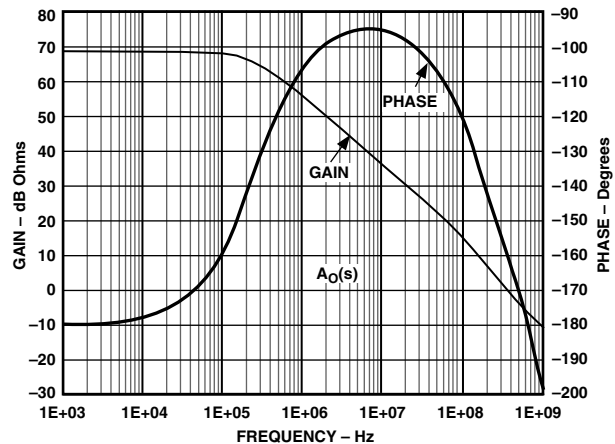

Figure 30. Open-Loop Voltage Gain and Phase

where R_1 is the input resistance to A_2/A_2B , and τ_1 (equal to $CD \times R_1 \times A_2$) is the open loop dominate time constant.

$$\text{and } T_O(s) = \frac{|A_2| \times R_1}{2s\tau_1 + 1}$$

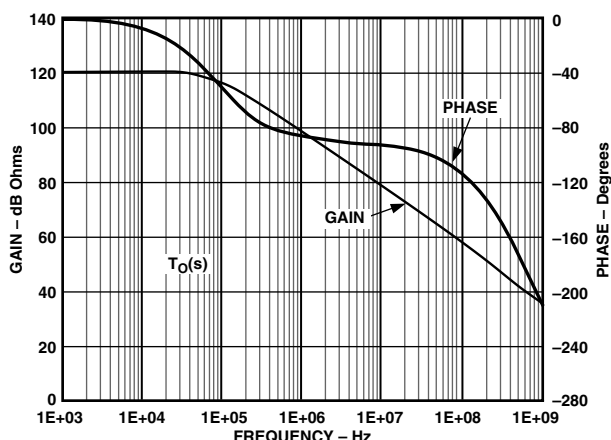

Figure 31. Open-Loop Transimpedance Gain

Note that the ac open-loop plots in Figures 31, 32 and 33 are based on the full Spice AD8011 simulations and do not include external parasitics (see below). Nevertheless, these ac loop equations still provide a good approximation to simulated and actual performance up to the CLBW of the amplifier. Typically $g_{mc} \times R_1$ is -4 , resulting in $A_O(s)$ having a right half plane pole. In the time domain (inverse Laplace of A_O) it appears as unstable, causing V_O to exponentially rail out of its linear region. When the loop is closed however, the BW is greatly extended and the transimpedance gain, $T_O(s)$ “overrides” and directly controls the amplifiers stability behavior due to Z_I approaching $1/2 g_{mf}$ for $s \gg 1/\tau_1$. See Figure 32. This can be seen by the $Z_I(s)$ and $A_V(s)$ noninverting transfer equations below.

$$Z_I(s) = \frac{(1 - g_{mc} \times R_1) \left[\frac{S\tau_1}{1 - g_{mf} \times R_1} + 1 \right]}{2 \times g_{mf} (S\tau_1 + 1)}$$

$$A_V(s) = \frac{G}{\left[1 + \frac{G}{A_O} + \frac{R_F}{T_O} \right] \left[S\tau_1 \left(\frac{G}{2 g_{mf} T_O} + \frac{R_F}{T_O} \right) + 1 \right]}$$

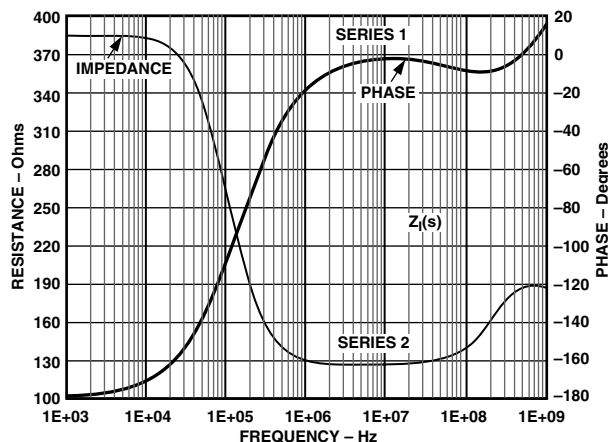

Figure 32. Open-Loop Inverting Input Impedance

$Z_I(s)$ goes positive real and approaches $1/2 g_{mf}$ as ω approaches $(g_{mc} \times R_1 - 1)/\tau_1$. This results in the input resistance for the $A_V(s)$ complex term being $1/2 g_{mf}$; the parallel thermal emitter resistances of Q_3/Q_4 . Using the computed CLBW from $A_V(s)$ above and the nominal design values for the other parameters, results in a closed loop 3 dB BW equal to the open loop corner frequency ($1/2 \pi\tau_1$) times $1/[G/(2 g_{mf} \times T_O) + R_F/T_O]$. For a fixed R_F , the 3 dB BW is controlled by the R_F/T_O term for low gains and $G/(2 g_{mf} \times T_O)$ for high gains. For example, using nominal design parameters and $R_1 = 1 \text{ k}\Omega$ (which results in a nominal T_O of $1.2 \text{ M}\Omega$), the computed BW is 80 MHz for $G = 0$ (inverting I-V mode with R_N removed) and 40 MHz for $G = +10/-9$.

DRIVING CAPACITIVE LOADS

The AD8011 was designed primarily to drive nonreactive loads. If driving loads with a capacitive component is desired, best settling response is obtained by the addition of a small series resistance as shown in Figure 33. The accompanying graph shows the optimum value for R_{SERIES} vs. capacitive load. It is worth noting that the frequency response of the circuit when driving large capacitive loads will be dominated by the passive roll-off of R_{SERIES} and C_L .

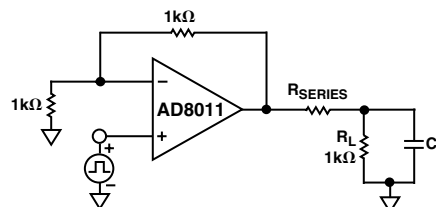

Figure 33. Driving Capacitive Load

AD8011

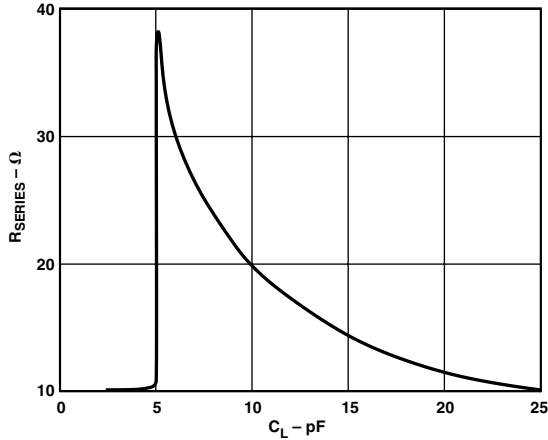

Figure 34. Recommended R_{SERIES} vs. Capacitive Load for ≤ 30 ns Settling to 0.1%

OPTIMIZING FLATNESS

As mentioned, the ac transfer equations above are based on a simplified single pole model. Due to the devices internal parasitics (primarily CP1/CP1B and CP2 in Figure 28) and external package/board parasitics (partially represented in Figure 34) the computed BW, using the $V_O(s)$ equation above, typically will be lower than the AD8011's measured small signal BW. See data sheet Bode plots.

With internal parasitics included only, the BW is extended do to the complex pole pairs created primarily by CP1/CP2B and CP2 versus the single-pole assumption shown above. This results in a "design controlled" closed-loop damping factor (ζ) of nominally 0.6 resulting in the CLBW increasing by approximately $1.3\times$ higher than the computed single pole value above for optimized external gains of $+2/-1$! As external noninverting gain (G) is increased, the actual closed-loop bandwidth vs. the computed single pole ac response is in closer agreement.

Inverting pin and external component capacitance (designated C_P) will further extend the CLBW do the closed loop zero created by C_P and $R_N \parallel R_F$ when operating in the noninverting mode. Using proper R_F component and layout techniques (see layout section) this capacitance should be about 1.5 pF. This results in a further incremental BW increase of almost $2\times$ (versus the computed value) for $G = +1$ decreasing and approaching its complex pole pair BW for gains approaching $+6$ or higher. As previously discussed, the single-pole response begins to correlate well. Note that a pole is also created by $1/2 g_{mf}$ and C_P which prevents the AD8011 from becoming unstable. This parasitic has the greatest effect on BW and peaking for low positive gains as the data sheet Bode plots clearly show. For inverting operation, C_P has relatively much less effect on CLBW variation.

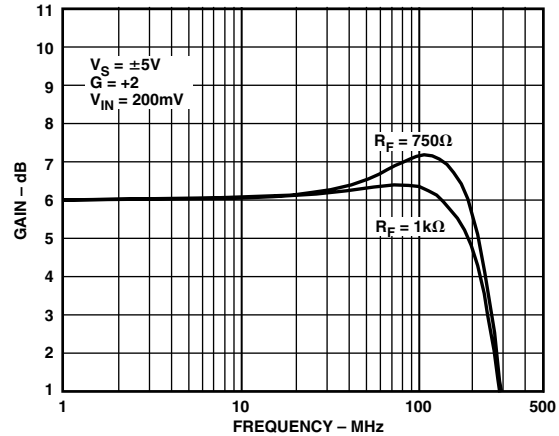

Figure 35. Flatness vs. Feedback

Output pin and external component capacitance (designated C_L) will further extend the devices BW and can also cause peaking below and above the CLBW if too high. In the time domain, poor step settling characteristics (ringing up to about 2 GHz and excessive overshoot) can result. For high C_L values greater than about 5 pF an external series "damping" resistor is recommended. See section on Settling Time vs. C_L . For light loads, any output capacitance will reflect back on A2's output (Z2 of buffer A3) as both added capacitance near the CLBW ($CLBW > f_T/B$) and eventually negative resistance at much higher frequencies. These added effects are proportional to the load C. This reflected capacitance and negative resistance has the effect of both reducing A2/s phase margin and causing high frequency " $L \times C$ " peaking respectively. Using an external series resistor (as specified above) reduces these unwanted effects by creating a reflected zero to A2's output which will reduce the peaking and eliminate ringing. For heavy resistive loads, relatively more Load C would be required to cause these same effects.

High inductive parasitics, especially on the supplies and inverting/noninverting inputs, can cause modulated low level R_F ringing on the output in the transient domain. Again, proper R_F component and board layout practices need to be observed. Relatively high parasitic lead inductance (roughly $L > 15$ nh) can result in $L \times C$ underdamped ringing. Here L/C means all associated input pin, external component and leadframe strays including collector to substrate device capacitance. In the ac domain, this $L \times C$ resonance effect would typically not appear in the pass-band of the amplifier but would appear in the open loop response at frequencies well above the CLBW of the amplifier.

INCREASING BW AT HIGH GAINS

As presented above, for a fixed R_F (feedback gain setting resistor) the AD8011 CLBW will decrease as R_N is reduced (increased G). This effect can be minimized by simply reducing R_F and thus partially restoring the devices optimized BW for gains greater than $+2/-1$. Note that the AD8011 is ac optimized (high BW and low peaking) for $A_V = +2/-1$ and R_F equal to 1 k Ω . Using this optimized G as a reference and the $V_O(s)$ equations above, the following relationships results:

$R_F = 1k + 2 - G/2 gm$ for $G = 1 + R_F/R_N$
(noninverting) or:

$R_F = 1k + G + 1/2 gm$ for $G = -R_F/R_N$
(inverting)

Using $1/2 gm$ equal to 120 Ω results in a R_F of 500 Ω for $G = 5/-4$ and a corresponding R_N of 125 Ω . This will extend the AD8011's BW to near its optimum design value of typically 180 MHz at $R_L = 1$ k Ω . In general, for gains greater than $+7/-6$, R_F should not be reduced to values much below 400 Ω else ac peaking can result. Using this R_F value as the a lower limit, will result in BW restoration near its optimized value to the upper G values specified. Gains greater than about $+7/-6$ will result in CLBW reduction. Again, the derivations above are just approximations.

DRIVING A SINGLE-SUPPLY A/D CONVERTER

New CMOS A/D converters are placing greater demands on the amplifiers that drive them. Higher resolutions, faster conversion rates and input switching irregularities require superior settling characteristics. In addition, these devices run off a single +5 V supply and consume little power, so good single-supply operation with low power consumption are very important. The AD8011 is well positioned for driving this new class of A/D converters.

Figure 36 shows a circuit that uses an AD8011 to drive an AD876, a single supply, 10-bit, 20 MSPS A/D converter that requires only 140 mW. Using the AD8011 for level shifting and driving, the A/D exhibits no degradation in performance compared to when it is driven from a signal generator.

The analog input of the AD876 spans 2 V centered at about 2.6 V. The resistor network and bias voltages provide the level shifting and gain required to convert the 0 V to 1 V input signal to a 3.6 V to 1.6 V range that the AD876 wants to see.

Biasing the noninverting input of the AD8011 at 1.6 V dc forces the inverting input to be at 1.6 V dc for linear operation of the amplifier. When the input is at 0 V, there is 3.2 mA flowing out of the summing junction via R1 (1.6 V/499 Ω). R3 has a current of 1.2 mA flowing into the summing junction (3.6 V–1.6 V)/1.65 k Ω . The difference of these two currents (2 mA) must flow through R2. This current flows toward the summing junction and requires that the output be 2 V higher than the summing junction or at 3.6 V.

When the input is at 1 V, there is 1.2 mA flowing into the summing junction through R3 and 1.2 mA flowing out through R1. These currents balance and leave no current to flow through R2. Thus the output is at the same potential as the inverting input or 1.6 V.

The input of the AD876 has a series MOSFET switch that turns on and off at the sampling rate. This MOSFET is connected to a hold capacitor internal to the device. The on impedance of the MOSFET is about 50 Ω , while the hold capacitor is about 5 pF.

In a worst case condition, the input voltage to the AD876 will change by a full-scale value (2 V) in one sampling cycle. When the input MOSFET turns on, the output of the op amp will be connected to the charged hold capacitor through the series resistance of the MOSFET. Without any other series resistance, the instantaneous current that flows would be 40 mA. This would cause settling problems for the op amp.

The series 100 Ω resistor limits the current that flows instantaneously after the MOSFET turns on to about 13 mA. This resistor cannot be made too large or the high frequency performance will be affected.

The sampling MOSFET of the AD876 is closed for only half of each cycle or for 25 ns. Approximately 7 time constants are required for settling to 10 bits. The series 100 Ω resistor along with the 50 Ω on resistance and the hold capacitor, create a 750 ps time constant. These values leave a comfortable margin for settling. Obtaining the same results with the op amp A/D combination as compared to driving with a signal generator indicates that the op amp is settling fast enough.

Overall the AD8011 provides adequate buffering for the AD876 A/D converter without introducing distortion greater than that of the A/D converter by itself.

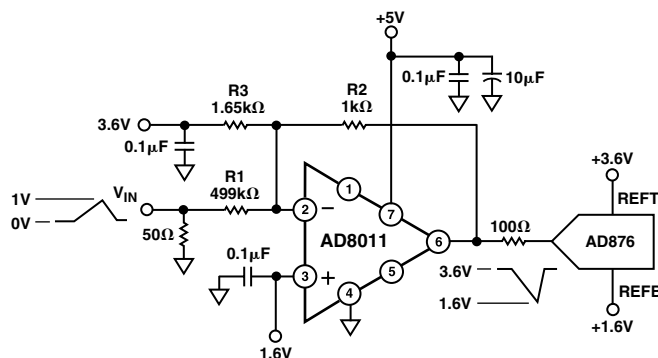

Figure 36. AD8011 Driving the AD876

AD8011

LAYOUT CONSIDERATIONS

The specified high speed performance of the AD8011 requires careful attention to board layout and component selection.

Table I shows the recommended component values for the AD8011 and Figures 38–40 show the layout for the AD8011 evaluation board (8-lead SOIC, Gain = +2). Proper R_F design techniques and low parasitic component selection are mandatory.

The PCB should have a ground plane covering all unused portions of the component side of the board to provide a low impedance ground path. The ground plane should be removed from the area near the input pins to reduce stray capacitance.

Chip capacitors should be used for supply bypassing (see Figure 37). One end should be connected to the ground plane and the other within 1/8 in. of each power pin. An additional (4.7 μF –10 μF) tantalum electrolytic capacitor should be connected in parallel.

The feedback resistor should be located close to the inverting input pin in order to keep the stray capacitance at this node to a minimum. Capacitance greater than 1.5 pF at the inverting input will significantly affect high speed performance when operating at low noninverting gains.

Stripline design techniques should be used for long signal traces (greater than about 1 in.). These should be designed with the proper system characteristic impedance and be properly terminated at each end.

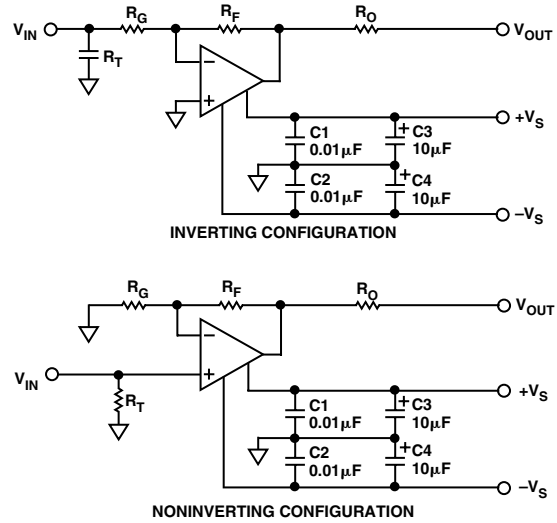

Figure 37. Inverting and Noninverting Configurations

Table I. Typical Bandwidth vs. Gain Setting Resistors

Gain	R_F (Ω)	R_G (Ω)	R_T (Ω)	Small Signal -3 dB BW (MHz), $V_S = \pm 5$ V
-1	1000	1000	52.3	150
-2	1000	499	54.9	130
-10	499	49.9		140
+1	1000		49.9	400
+2	1000	1000	49.9	250
+10	422	47.5	49.9	100
+6	1000	200	49.9	70
+6	500	100	49.9	170

R_T chosen for 50 Ω characteristic input impedance.

R_O chosen for characteristic output impedance.

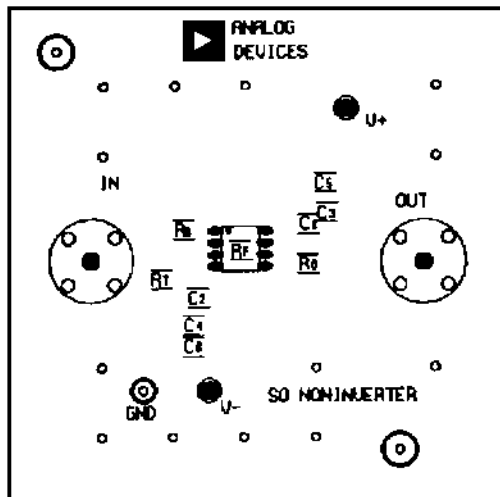

Figure 38. Evaluation Board Silkscreen (Top)

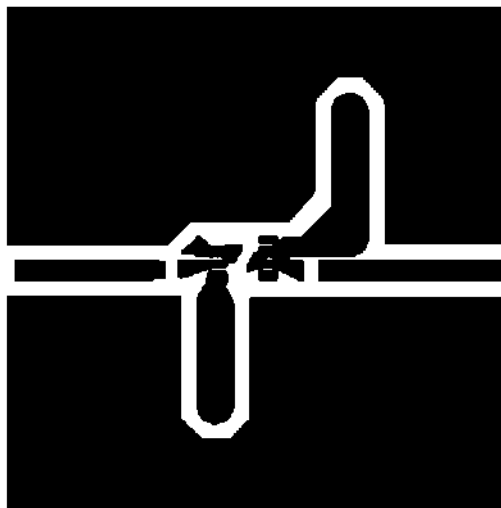

Figure 39. Evaluation Board Layout (Solder Side)

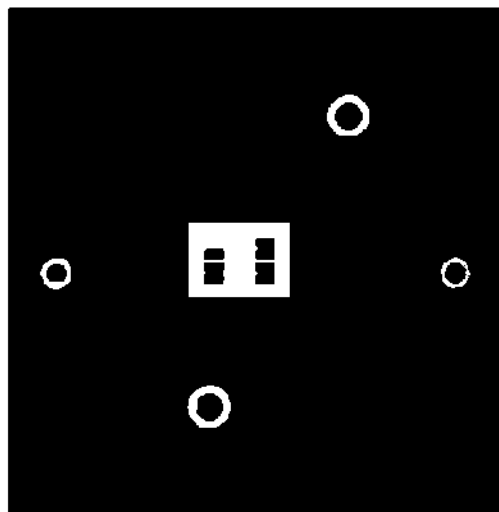
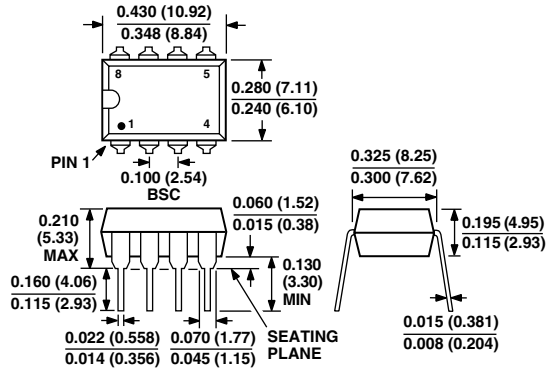

Figure 40. Evaluation Board Layout (Component Side)

OUTLINE DIMENSIONS

Dimensions shown in inches and (mm).

**8-Lead Plastic DIP
(N-8)**



**8-Lead Plastic SOIC
(SO-8)**

