

IRFI840GPbF

HEXFET® Power MOSFET

- Isolated Package
- High Voltage Isolation= 2.5KVRMS ⑤
- Sink to Lead Creepage Dist.= 4.8mm
- Dynamic dv/dt Rating
- Low Thermal Resistance
- Lead-Free

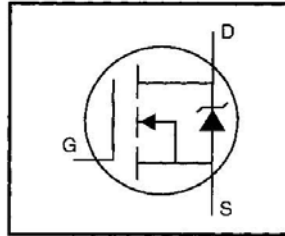

$$V_{DSS} = 500V$$

$$R_{DS(on)} = 0.85\Omega$$

$$I_D = 4.6A$$

Description

Third Generation HEXFETs from International Rectifier provide the designer with the best combination of fast switching, ruggedized device design, low on-resistance and cost-effectiveness.

The TO-220 Fullpak eliminates the need for additional insulating hardware in commercial-industrial applications. The moulding compound used provides a high isolation capability and a low thermal resistance between the tab and external heatsink. This isolation is equivalent to using a 100 micron mica barrier with standard TO-220 product. The Fullpak is mounted to a heatsink using a single clip or by a single screw fixing.

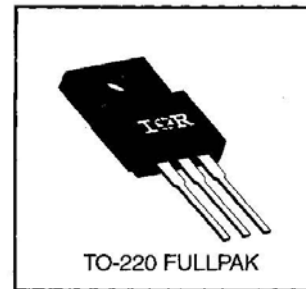

Absolute Maximum Ratings

	Parameter	Max.	Units
$I_D @ T_C = 25^\circ C$	Continuous Drain Current, $V_{GS} @ 10 V$	4.6	A
$I_D @ T_C = 100^\circ C$	Continuous Drain Current, $V_{GS} @ 10 V$	2.9	
I_{DM}	Pulsed Drain Current ①	18	
$P_D @ T_C = 25^\circ C$	Power Dissipation	40	W
	Linear Derating Factor	0.32	W/°C
V_{GS}	Gate-to-Source Voltage	± 20	V
E_{AS}	Single Pulse Avalanche Energy ②	370	mJ
I_{AR}	Avalanche Current ①	4.6	A
E_{AR}	Repetitive Avalanche Energy ①	4.0	mJ
dv/dt	Peak Diode Recovery dv/dt ③	3.5	V/ns
T_J	Operating Junction and Storage Temperature Range	-55 to +150	
T_{STG}			
	Mounting Torque, 6-32 or M3 screw	10 lbf•in (1.1 N•m)	

Thermal Resistance

	Parameter	Min.	Typ.	Max.	Units
$R_{\theta JC}$	Junction-to-Case	—	—	3.1	°C/W
$R_{\theta JA}$	Junction-to-Ambient	—	—	65	

Electrical Characteristics @ T_J = 25°C (unless otherwise specified)

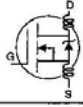
	Parameter	Min.	Typ.	Max.	Units	Test Conditions
V _{(BR)DSS}	Drain-to-Source Breakdown Voltage	500	—	—	V	V _{GS} =0V, I _D =250μA
ΔV _{(BR)DSS} /ΔT _J	Breakdown Voltage Temp. Coefficient	—	0.78	—	V/°C	Reference to 25°C, I _D =1mA
R _{DS(on)}	Static Drain-to-Source On-Resistance	—	—	0.85	Ω	V _{GS} =10V, I _D =2.8A ④
V _{GS(th)}	Gate Threshold Voltage	2.0	—	4.0	V	V _{DS} =V _{GS} , I _D =250μA
g _{fs}	Forward Transconductance	3.7	—	—	S	V _{DS} =50V, I _D =2.8A ④
I _{DSS}	Drain-to-Source Leakage Current	—	—	25	μA	V _{DS} =500V, V _{GS} =0V
		—	—	250	μA	V _{DS} =400V, V _{GS} =0V, T _J =125°C
I _{GSS}	Gate-to-Source Forward Leakage	—	—	100	nA	V _{GS} =20V
	Gate-to-Source Reverse Leakage	—	—	-100	nA	V _{GS} =-20V
Q _g	Total Gate Charge	—	—	67	nC	I _D =8.0A
Q _{gs}	Gate-to-Source Charge	—	—	10	nC	V _{DS} =400V
Q _{gd}	Gate-to-Drain ("Miller") Charge	—	—	34	nC	V _{GS} =10V See Fig. 6 and 13 ④
t _{d(on)}	Turn-On Delay Time	—	14	—	ns	V _{DD} =250V I _D =8.0A R _G =9.1Ω R _D =31Ω See Figure 10 ④
t _r	Rise Time	—	22	—		
t _{d(off)}	Turn-Off Delay Time	—	55	—		
t _f	Fall Time	—	21	—		
L _D	Internal Drain Inductance	—	4.5	—	nH	Between lead, 6 mm (0.25in.) from package and center of die contact 
L _S	Internal Source Inductance	—	7.5	—		
C _{iss}	Input Capacitance	—	1300	—	pF	V _{GS} =0V V _{DS} =25V f=1.0MHz See Figure 5
C _{oss}	Output Capacitance	—	200	—		
C _{rss}	Reverse Transfer Capacitance	—	39	—		
C	Drain to Sink Capacitance	—	12	—		

Source-Drain Ratings and Characteristics

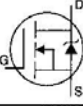
	Parameter	Min.	Typ.	Max.	Units	Test Conditions
I _S	Continuous Source Current (Body Diode)	—	—	4.6	A	MOSFET symbol showing the integral reverse p-n junction diode. 
I _{SM}	Pulsed Source Current (Body Diode) ①	—	—	18		
V _{SD}	Diode Forward Voltage	—	—	2.0	V	T _J =25°C, I _S =4.6A, V _{GS} =0V ④
t _{rr}	Reverse Recovery Time	—	340	680	ns	T _J =25°C, I _F =8.0A
Q _{rr}	Reverse Recovery Charge	—	1.8	2.6	μC	di/dt=100A/μs ④
t _{on}	Forward Turn-On Time	intrinsic turn-on time is negligible (turn-on is dominated by L _S +L _D)				

Notes:

- ① Repetitive rating; pulse width limited by max. junction temperature (See Figure 11)
- ② V_{DD}=50V, starting T_J=25°C, L=31mH R_G=25Ω, I_{AS}=4.6A (See Figure 12)
- ③ I_{SD}≤8.0A, di/dt≤100A/μs, V_{DD}≤V_{(BR)DSS}, T_J≤150°C
- ④ Pulse width ≤ 300 μs; duty cycle ≤2%.
- ⑤ t=60s, f=60Hz

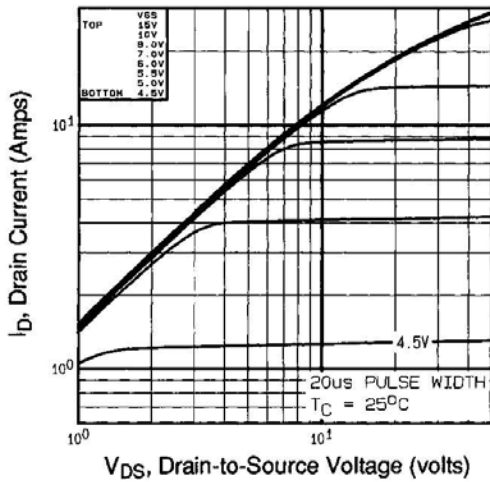

Fig 1. Typical Output Characteristics,
 $T_C=25^\circ\text{C}$

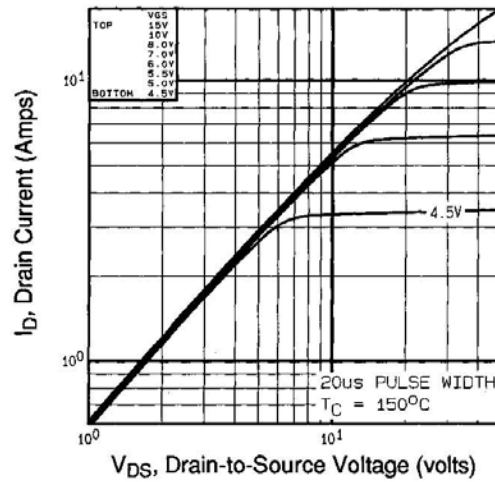

Fig 2. Typical Output Characteristics,
 $T_C=150^\circ\text{C}$

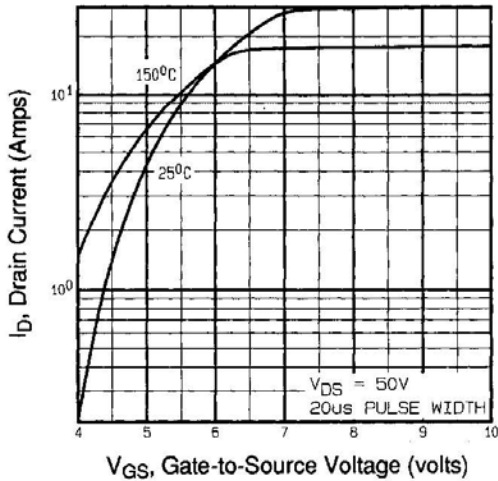

Fig 3. Typical Transfer Characteristics

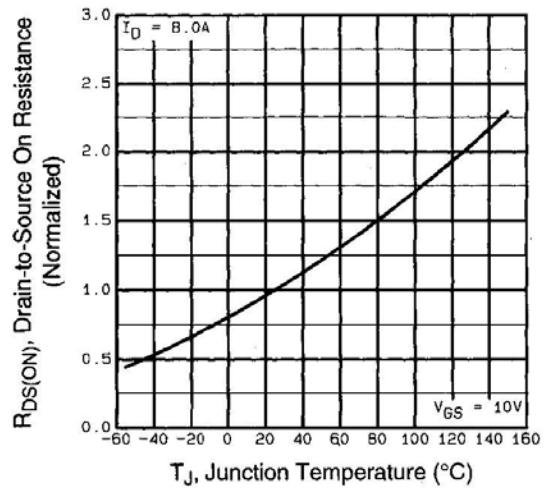

Fig 4. Normalized On-Resistance
Vs. Temperature

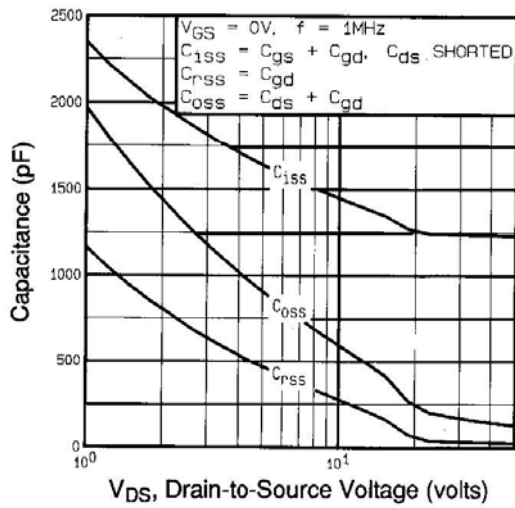

Fig 5. Typical Capacitance Vs. Drain-to-Source Voltage

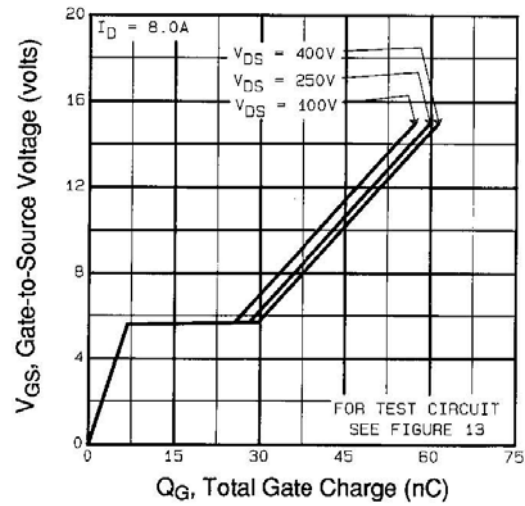

Fig 6. Typical Gate Charge Vs. Gate-to-Source Voltage

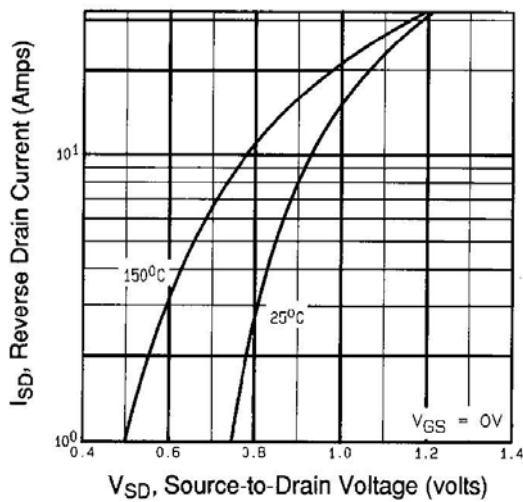

Fig 7. Typical Source-Drain Diode Forward Voltage

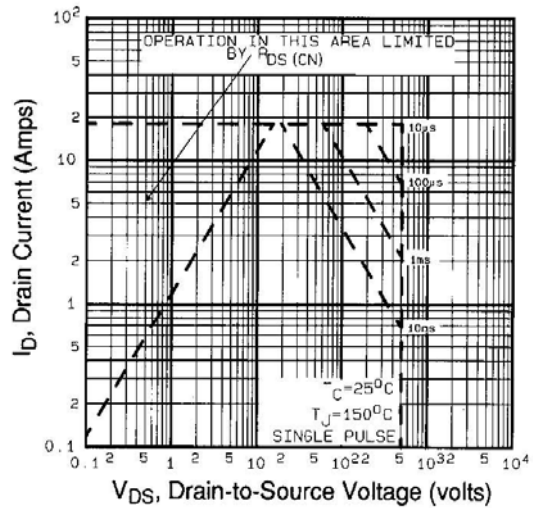

Fig 8. Maximum Safe Operating Area

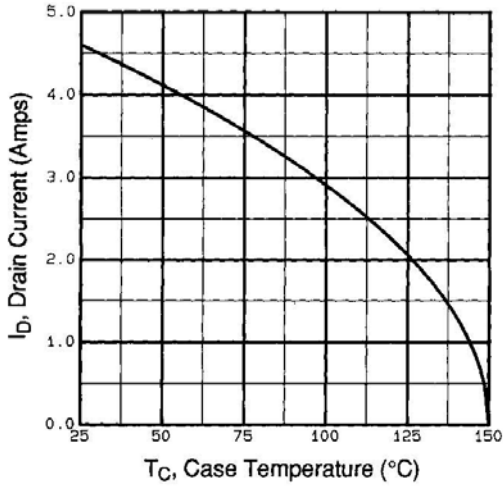

Fig 9. Maximum Drain Current Vs. Case Temperature

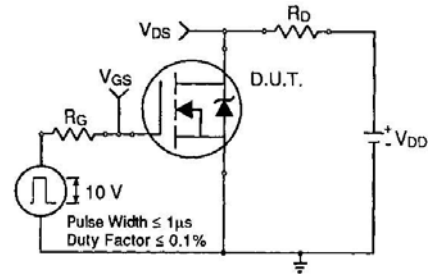

Fig 10a. Switching Time Test Circuit

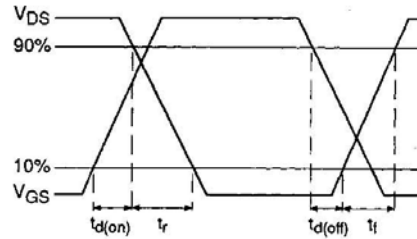

Fig 10b. Switching Time Waveforms

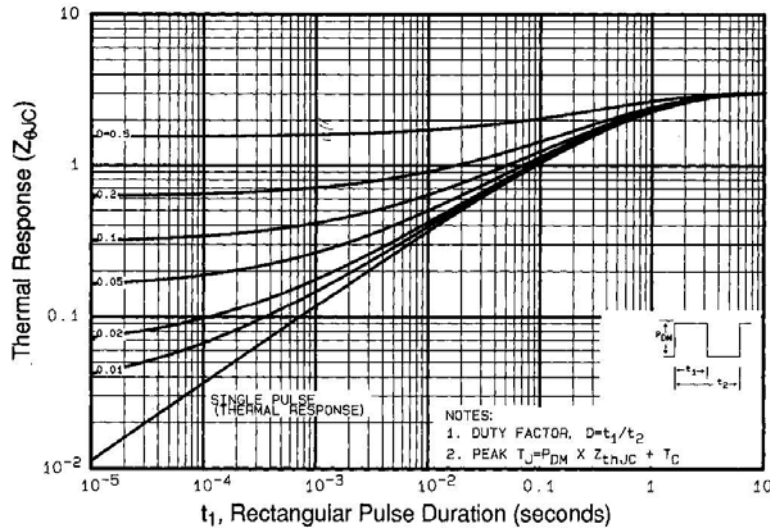

Fig 11. Maximum Effective Transient Thermal Impedance, Junction-to-Case

IRFI840GPbF

International
IOR Rectifier

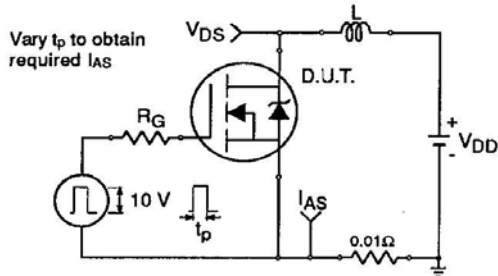

Fig 12a. Unclamped Inductive Test Circuit

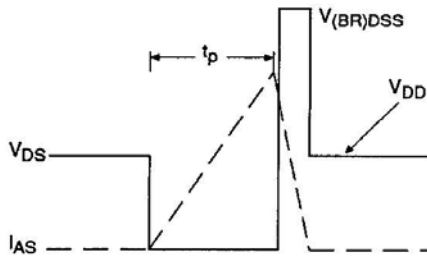

Fig 12b. Unclamped Inductive Waveforms

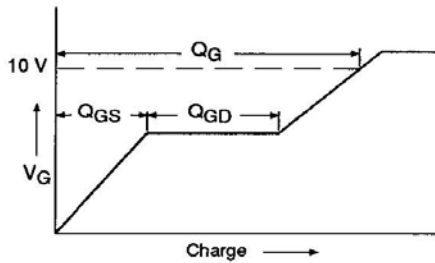

Fig 13a. Basic Gate Charge Waveform

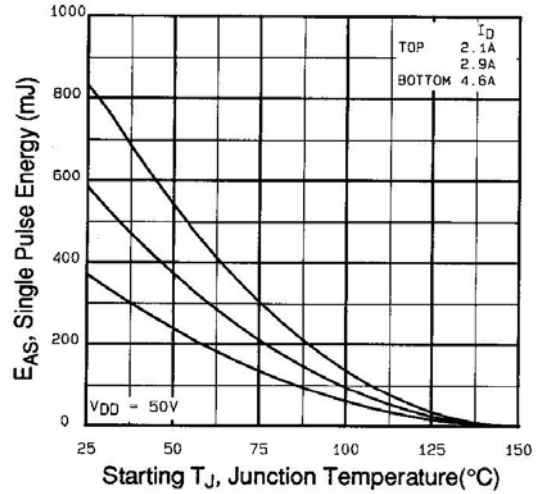

Fig 12c. Maximum Avalanche Energy Vs. Drain Current

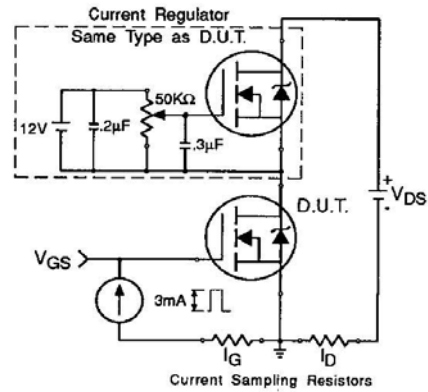

Fig 13b. Gate Charge Test Circuit

Appendix A: Figure 14, Peak Diode Recovery dv/dt Test Circuit – See page 1505

Appendix B: Package Outline Mechanical Drawing – See page 1510

International
IOR Rectifier
www.irf.com

TO-220 Full-Pak Package Outline

Dimensions are shown in millimeters (inches)

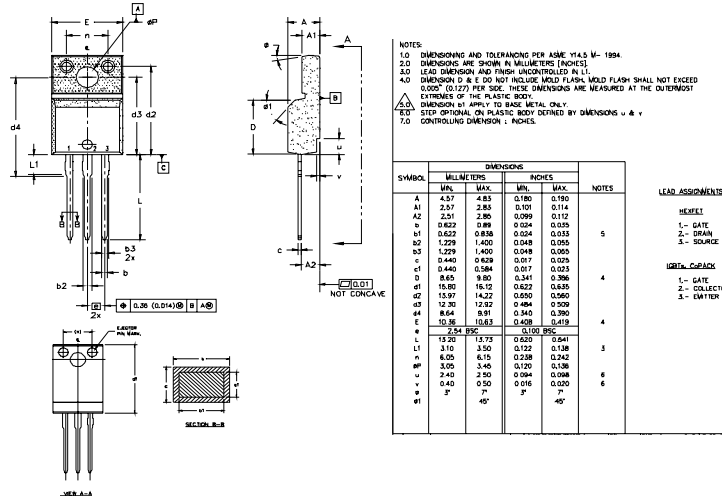

TO-220 Full-Pak Part Marking Information

EXAMPLE: THIS IS AN IRF1840G
 WITH ASSEMBLY
 LOT CODE 3432
 ASSEMBLED ON WW 24 1999
 IN THE ASSEMBLY LINE "K"
Note: "P" in assembly line
 position indicates "Lead-Free"

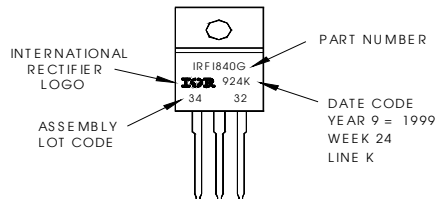

Data and specifications subject to change without notice.

Note: For the most current drawings please refer to the IR website at:
<http://www.irf.com/package/>